

# ENSIM

*Measuring Excellence*

PROCESS CONTROL  
SENSORS

## SENSORS

Since 1984

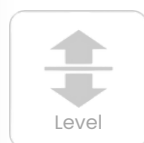

Level



Flow



Pressure



Temperature



Valve

# ABOUT US

LONCA A.Ş. is one of the leading companies of Turkey in measurement-control devices since 1984. Lonca has been providing wide range of products under brand "Ensim Sensors" while also importing other type of models to meet requirements of automation sector.

LONCA A.Ş. always driven with the spirit of innovation and a passion for a contribution to make industry easier everyday. While our production capacity is growing , LONCA A.Ş. adds different quality certifications such as: ATEX, ISO 9001, ISO 27001, ISO 50001, ISO 10002, ISO 22301, ISO 45001, ISO 14001, ISO 80079-34 under it's organization every year.

Ensim Sensors product portfolio offers wide range of options in measurement instruments including Level , Flow , Pressure , Temperature sensors , Calibration Bath and Control Equipment.



## PRODUCT

### LEVEL

- Capacitive Type Level Switch
- Capacitive Type Level Transmitter
- OEM Capacitive Type Level Sensor
- Float Type Level Switch
- Float Type Level Transmitter
- Side Mounting Type Level Switch
- By-Pass Magnetic Level Gauge
- Reflex Type Level Gauge
- Rotary Paddle Level Switch
- Vibrating Rod Type Level Switch
- Float Type Mini Level Switch – Metal Version
- Float Type Mini Level Switch – Plastic Version
- Conductivity Type Level Switch
- Water , Oil , Acid Warning Dedector
- Radar Type Level Transmitter
- Membrane Type Level Switch
- Tilt Switch
- Cable Level Switch
- Float Valve
- Sight Level Indicator

### FLOW

- Flow Switch
- Flow Indicator
- Flow Measurement with Orifice
- E / M Flowmeter
- Pitot Tube

### PRESSURE

- Pressure Switch
- Differential Pressure Switch
- Differential Pressure Gauge
- Cooling Apparatus

### TEMPERATURE

- Temperature Transmitter
- Temperature Sensor
- Thermowell

### CONCENTRATION

- In-line Liquid Conc. Measurement

### CONTROL

- GSM / GPRS / Wi-fi / RF Control
- ModBus I/O Module
- USB-RS 485 Converter
- GSM-GPRS Modem
- Tank Filling System

### CALIBRATION

- Dry-Well Calibrator
- Calibration Bath

### ANALYSIS

- PH Measurement
- ORP Measurement



# CATALOG CONTENTS

## LEVEL



ECAP .....	1
ECAS .....	2
ECAPm / ECAPe / ECAPr .....	3
ECASm / ECASe / ECAM .....	4
ELS .....	5
ELS-tx .....	6
ELB .....	7
ELG .....	8 - 9
EMT .....	10
ELH .....	11
ELF .....	12 - 13
ELM .....	14
ELP .....	15
ELC .....	16
ISS / ELC .....	17
WATERSENS .....	18
ELW .....	19 - 20
EGW .....	21
ELT .....	22
ELZ .....	23
E-TILT .....	24
ELA / ELAr .....	25
ELV / EYG .....	26
ELD .....	27

## FLOW



EFS / EFD .....	28 - 31
ENABAR / ENVORTEX .....	32
EFO .....	33
EFM .....	34
EF .....	35 - 36

## PRESSURE



EPS .....	37 - 39
ELX .....	40 - 41

## TEMPERATURE



ETT .....	42
-----------	----

## ANALYSIS & CONTROL



EPH .....	43
EBQ .....	44 - 46

## PARTNERSHIPS



BD SENSORS .....	47 - 48
GALLTEC + MELA .....	49
HUMIMETER .....	50
VAISALA .....	51 - 52



# CERTIFICATES

## BRAND NAME

**T.C. TÜRK PATENT VE MARKA KURUMU**  
**MARKA TESCİL BELGESİ**  
 Marka No : 2018 29916 - Ticaret - Hizmet

**ENsim SENSORS**

Marka Sahibi : LONCA MAKİNA SANAYİ TİCARET ANONİM ŞİHETİ  
 YERLİK Y. CUMHURİYETİ  
 Pınar Yolu Cad. Suda Sokak No:20 Kampüsü Beşiktaş / İstanbul  
 Emtilau : 07 - 09 - 37  
 İhstikdir.

İşbu Marka 26/03/2018 tarihinde itibaren ON YIL süreyle 05/09/2018 tarihinde tescil edilmiştir.

**TURK PATENT**

Prof. Dr. Mahir ASAN  
 Türk Patent ve Marka Kurumu Başkanı

## ISO 9001 : 2015

**LONCA MAKİNA SAN. VE TİC. A.Ş.**  
 FERİHATPAŞA MAH. GAZIPAŞA CAD. NO:104 A ATAŞEHİR, İSTANBUL, TÜRKİYE

Bureau Veritas Belgelendirme yukarıda adı geçen kuruluşun, Yönetim Sisteminin düzenlenmiş ve sağlığı değerlendirilerek yönetim sistemi standartlarının gereklerine uygunluğunu onaylamaktadır.

**ISO 9001:2015**  
 Belgelendirme Kapsamı  
 ÖLÇÜ VE KONTROL ALETLERİ TASARIMI, ÜRETİMİ, SATIŞI VE SATIŞ SONRASI HİZMETLERİ

İk Döngü Başlangıç Tarihi: 02-05-2013  
 Önceki Döngü Geçerlilik Tarihi: NA  
 Belgelendirme / Yeniden Belgelendirme Denetim Tarihi: NA  
 Belgelendirme / Yeniden Belgelendirme Döngüsü Başlangıç Tarihi: 12-08-2021  
 Kuruluşun yönetim sistemi, standartları yetkililikleri kapsamında devam ettiği sürece bu sertifikaya geçerlidir: 12-08-2024

Sertifika Numarası: TR010678 Sürüm: 1 Yayın Tarihi: 12-08-2021

**BUREAU VERITAS**  
 Bureau Veritas Certification

## ISO 14001: 2015

**Registered CCPL**  
**Registration Certificate**  
 This is to certify that The Management Systems of

**LONCA MAKİNA SAN. TİC. A.Ş.**  
 Carried out at following site:  
**Ferhatpaşa Mahallesi, Gazipaşa Caddesi, No:104 A PK: 34888 Ataşehir İSTANBUL/TÜRKİYE**

Has been found to conform to the environmental management system Standard:

**ISO 14001:2015**  
 This certificate is valid for the following Product or Service ranges:  
**Design, Production, Sales and After Sales Services of Measurement and Control Instruments (Ölçü ve Kontrol Aletleri Tasarımı, Üretimi, Satışı ve Satış Sonrası Hizmetleri)**

CERTIFICATE NO. : IAS/EMS/G/1111  
 ISSUED ON : 15/09/2022 1<sup>st</sup> SURVEILLANCE DUE ON: 15/09/2023  
 VALIDITY DATE : 14/09/2025 2<sup>nd</sup> SURVEILLANCE DUE ON: 15/09/2024

THE VALIDITY OF CERTIFICATE IS SUBJECT TO REGULAR SURVEILLANCE AUDIT ON OR BEFORE ABOVE MENTIONED DATES AND IT'S ONLY VALID AFTER SUCCESSFUL SURVEILLANCE WITH CONTINUATION LETTER ISSUED BY CCPL.

**Care Certification Private Limited**  
 3365 Salem Street, Suite 100, Brea, California 92821-1721, USA  
 www.carecertification.org

## ISO 45001 : 2018

**Registered CCPL**  
**Registration Certificate**  
 This is to certify that The Management Systems of

**LONCA MAKİNA SAN. TİC. A.Ş.**  
 Carried out at following site:  
**Ferhatpaşa Mahallesi, Gazipaşa Caddesi, No:104 A PK: 34888 Ataşehir İSTANBUL/TÜRKİYE**

Has been found to conform to the occupational health and safety management systems Standard:

**ISO 45001:2018**  
 This certificate is valid for the following Product or Service ranges:  
**(Design, Production, Sales and After Sales Services of Measurement and Control Instruments (Ölçü ve Kontrol Aletleri Tasarımı, Üretimi, Satışı ve Satış Sonrası Hizmetleri)**

CERTIFICATE NO. : IAS/OHS/G/1097  
 ISSUED ON : 20/10/2022 1<sup>st</sup> SURVEILLANCE DUE ON: 20/09/2023  
 VALIDITY DATE : 19/10/2025 2<sup>nd</sup> SURVEILLANCE DUE ON: 20/09/2024

THE VALIDITY OF CERTIFICATE IS SUBJECT TO REGULAR SURVEILLANCE AUDIT ON OR BEFORE ABOVE MENTIONED DATES AND IT'S ONLY VALID AFTER SUCCESSFUL SURVEILLANCE WITH CONTINUATION LETTER ISSUED BY CCPL.

**Care Certification Private Limited**  
 3365 Salem Street, Suite 100, Brea, California 92821-1721, USA  
 www.carecertification.org

## ISO 27001: 2013

**COMPLIANCE CERTIFICATE**  
 This is to certify that The Management Systems of

**LONCA MAKİNA SAN. TİC. A.Ş.**  
 Carried out at following site:  
**Ferhatpaşa Mahallesi, Gazipaşa Caddesi, No:104 A PK: 34888 Ataşehir İSTANBUL/TÜRKİYE**

Has been found to conform to the Information Technology – Security Techniques – Information Security Management Systems Standard:

**ISO 27001:2013**  
 This certificate is valid for the following Product or Service ranges:  
**Design, Production, Sales and After Sales Services of Measurement and Control Instruments (Ölçü ve Kontrol Aletleri Tasarımı, Üretimi, Satışı ve Satış Sonrası Hizmetleri)**

Certificate no. : EIAZ/IT/2013-2022  
 Issued on : 12/12/2022  
 Validity Date : 11/12/2025  
 1<sup>st</sup> Surveillance Due On : 22/12/2023  
 2<sup>nd</sup> Surveillance Due On : 12/11/2024

THE VALIDITY OF CERTIFICATE IS SUBJECT TO REGULAR SURVEILLANCE AUDIT ON OR BEFORE ABOVE MENTIONED DATES AND IT'S ONLY VALID AFTER SUCCESSFUL SURVEILLANCE WITH CONTINUATION LETTER ISSUED BY PCMS.

**PCMS WORLDWIDE LTD**  
 Address : Kemp House, 160 City Road, London, EC1Y 2NX, United Kingdom  
 www.pcmsworld.com

## ISO 10002 : 2018

**COMPLIANCE CERTIFICATE**  
 This is to certify that The Management Systems of

**LONCA MAKİNA SAN. TİC. A.Ş.**  
 Carried out at following site:  
**Ferhatpaşa Mahallesi, Gazipaşa Caddesi, No:104 A PK: 34888 Ataşehir İSTANBUL/TÜRKİYE**

Has been found to conform to the quality management – customer satisfaction Standard:

**ISO 10002:2018**  
 This certificate is valid for the following Product or Service ranges:  
**Design, Production, Sales and After Sales Services of Measurement and Control Instruments (Ölçü ve Kontrol Aletleri Tasarımı, Üretimi, Satışı ve Satış Sonrası Hizmetleri)**

Certificate no. : EIAZ/OM/CS/1006-2022  
 Issued on : 20/04/2022  
 Validity Date : 19/04/2025  
 1<sup>st</sup> Surveillance Due On : 20/09/2023  
 2<sup>nd</sup> Surveillance Due On : 20/09/2024

THE VALIDITY OF CERTIFICATE IS SUBJECT TO REGULAR SURVEILLANCE AUDIT ON OR BEFORE ABOVE MENTIONED DATES AND IT'S ONLY VALID AFTER SUCCESSFUL SURVEILLANCE WITH CONTINUATION LETTER ISSUED BY PCMS.

**PCMS WORLDWIDE LTD**  
 Address : Kemp House, 160 City Road, London, EC1Y 2NX, United Kingdom  
 www.pcmsworld.com

## ISO 45001 : 2018

**Registered CCPL**  
**Registration Certificate**  
 This is to certify that The Management Systems of

**LONCA MAKİNA SAN. TİC. A.Ş.**  
 Carried out at following site:  
**Ferhatpaşa Mahallesi, Gazipaşa Caddesi, No:104 A PK: 34888 Ataşehir İSTANBUL/TÜRKİYE**

Has been found to conform to the quality management – customer satisfaction Standard:

**ISO 10002:2018**  
 This certificate is valid for the following Product or Service ranges:  
**Design, Production, Sales and After Sales Services of Measurement and Control Instruments (Ölçü ve Kontrol Aletleri Tasarımı, Üretimi, Satışı ve Satış Sonrası Hizmetleri)**

Certificate no. : EIAZ/OM/CS/1006-2022  
 Issued on : 20/04/2022  
 Validity Date : 19/04/2025  
 1<sup>st</sup> Surveillance Due On : 20/09/2023  
 2<sup>nd</sup> Surveillance Due On : 20/09/2024

THE VALIDITY OF CERTIFICATE IS SUBJECT TO REGULAR SURVEILLANCE AUDIT ON OR BEFORE ABOVE MENTIONED DATES AND IT'S ONLY VALID AFTER SUCCESSFUL SURVEILLANCE WITH CONTINUATION LETTER ISSUED BY PCMS.

**Care Certification Private Limited**  
 3365 Salem Street, Suite 100, Brea, California 92821-1721, USA  
 www.carecertification.org

## ISO 27001: 2013

**COMPLIANCE CERTIFICATE**  
 This is to certify that The Management Systems of

**LONCA MAKİNA SAN. TİC. A.Ş.**  
 Carried out at following site:  
**Ferhatpaşa Mahallesi, Gazipaşa Caddesi, No:104 A PK: 34888 Ataşehir İSTANBUL/TÜRKİYE**

Has been found to conform to the Business Continuity Management Systems Standard:

**ISO 22301 : 2019**  
 This certificate is valid for the following Product or Service ranges:  
**Design, Production, Sales and After Sales Services of Measurement and Control Instruments (Ölçü ve Kontrol Aletleri Tasarımı, Üretimi, Satışı ve Satış Sonrası Hizmetleri)**

Certificate no. : PCMS/BCM/ISO-2023  
 Issued on : 18/02/2023  
 Validity Date : 17/02/2026  
 1<sup>st</sup> Surveillance Due On : 18/02/2024  
 2<sup>nd</sup> Surveillance Due On : 18/02/2025

THE VALIDITY OF CERTIFICATE IS SUBJECT TO REGULAR SURVEILLANCE AUDIT ON OR BEFORE ABOVE MENTIONED DATES AND IT'S ONLY VALID AFTER SUCCESSFUL SURVEILLANCE WITH CONTINUATION LETTER ISSUED BY PCMS.

**PCMS WORLDWIDE LTD**  
 Address : Kemp House, 160 City Road, London, EC1Y 2NX, United Kingdom  
 www.pcmsworld.com

## EN ISO3834-2

**TÜV AUSTRIA**  
**CERTIFICATE**  
 The certification body of TÜV AUSTRIA SERVICES GMBH certifies that

**LONCA MAKİNA SAN. TİC. A.Ş.**  
**FERHATPAŞA MAHALLESİ, GAZIPAŞA CADESİ, NO: 104 A PK: 34888 ATAŞEHİR, İSTANBUL, TÜRKİYE**

has met all necessary quality requirements for welding according to

**EN ISO 3834-2**

Date of audit: 11.06.2022  
 This certificate is valid for the following products or service ranges:  
 Design and manufacture of measurement and survey instruments  
 Date of expiry: 10.06.2023

Certificate No.: HZ-04982-22-TR-OSY

Leonding 04.07.2022  
 PLACE DATE

**TÜV AUSTRIA SERVICES GMBH**  
 Dudenstraße 10  
 A-1220 Wien









# SYMBOLS



ATEX LEVEL

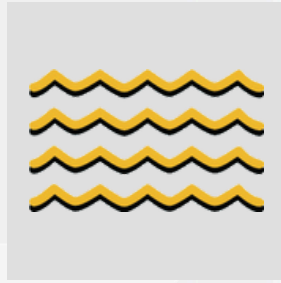

ATEX FLOW

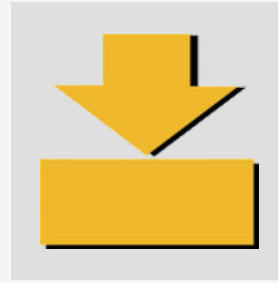

ATEX PRESSURE



ATEX TEMPERATURE

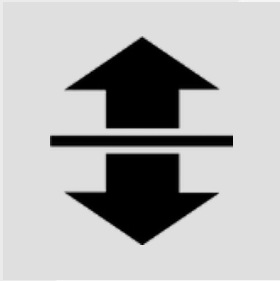

LEVEL

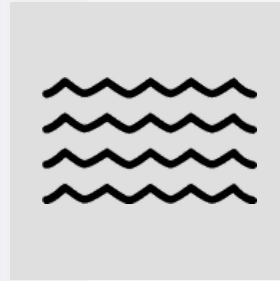

FLOW

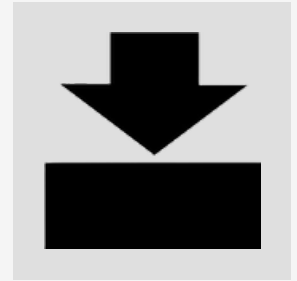

PRESSURE

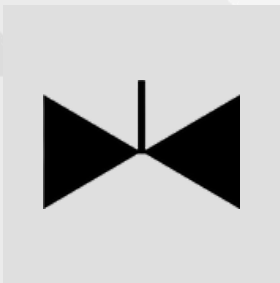

VALVE

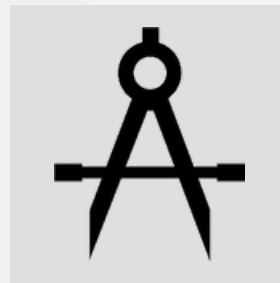

CALIBRATION

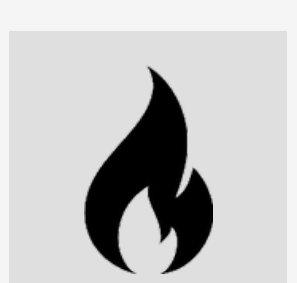

TEMPERATURE

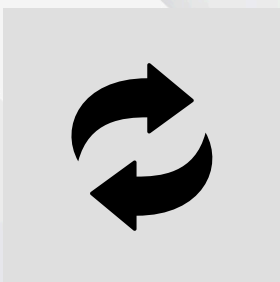

ANALYSIS & CONTROL

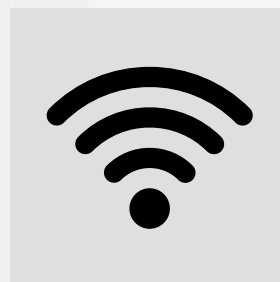

MONITORING  
AND TRACKING



LIQUID CNCENTRATION

# BRAND LOGOS



ENSIM SENSORS



ELORION SENSORS



CIHAZSEPETI



ENSIMSIGHT



ENBELLOW



ENABAR



ENWORTEX



ENFLOWS



WATERSENS



FUELSENS



MY ENSIM



ENSIM LIVE



## ECAP CAPACITIVE TYPE LEVEL TRANSMITTERS



### ► Technical Specifications

Supply	: 24 VDC
Signal Output	: 4-20 mA two wires Std. 0-20 mA - 4-20 mA, 0-10 V three wire Opt.
Accuracy	: $\pm 0,5\%$ , $\pm 0,8\%$ , $\pm 1\%$
Linearity	: $\pm 0,5\%$
Capacity Range	: 1 pF...3n F 1,6 $\epsilon r$
Connection Material	: 304 St.St. , Opt. 316 St.St.
Isolation Material	: PFA Std. Opt. PEEK, PTFE , Rubber, FKM
Housing Material	: PBT Std., Ops. Aluminium, St.St.
Working Pressure	: (-)1 bar...(+) 100 bar (Depending on the model)
Protection Class(EN60529)	: PBT-IP 66 , Aluminium , St.St. IP 65
Working Temperature	: (-) 40 °C / (+) 150 °C (Depending on the model) 200 °C with cooling apparatus (-) 196 °C For Cryogenic Tank, (-) 50 °C ... (+) 80 °C For NBR For FKM (-) 30 °C ... (+) 200 °C 400 °C with ceramic isolation
Ambient Temperature	: (-) 20 °C / (+) 60 °C
Display	: With LED-Power and Contact LED
Isolation	: Max. 500 V
Power Consumption	: Max. 50 mW
Electrical Connection	: Terminals
Protection Class (EN60529)	: IP 65, IP 66, IP 68

### ► ECAP

### ► DX-ECAP

Supply	: 24 VDC
Signal Output	: 4-20 mA two wires Std. 0-20 mA - 4-20 mA, 0-10 V three wire Opt.
Accuracy	: $\pm 0,5\%$ , $\pm 0,8\%$ , $\pm 1\%$
Linearity	: $\pm 0,5\%$
Capacity Range	: 1 pF...3n F 1,6 $\epsilon r$
Connection Material	: 304 St.St. , Opt. 316 St.St.
Isolation Material	: PFA Std. Opt. PEEK, PTFE , Rubber, FKM
Housing Material	: Aluminum Injection - AISi12Fe (Std)
Working Pressure	: (-) 1bar...(+) 25 bar (Depending on the model)
Protection Class	: IP 66
Working Temperature	: (-) 40 °C / (+) 150 °C (Depending on the model) 200 °C with cooling apparatus (-) 196 °C For Cryogenic Tank, (-) 50 °C ... (+) 80 °C For NBR For FKM (-) 30 °C ... (+) 200 °C 400 °C with ceramic isolation
Ambient Temperature	: (-) 20 °C / (+) 60 °C
Display	: With LED-Power and Contact LED
Isolation	: Max. 500 V
Power Consumption	: Max. 50 mW
Electrical Connection	: Terminals
Protection Class	: IP 66, IP 68

ECAP level transmitter is a capacitive level sensor for level measurement of conductive liquid, low conductive liquid, granulated materials with solid particles, adhesive and acid/basic liquids. When a material comes between electrode rod and tank wall, a capacitance change occurs and when this change exceed adjustment threshold, contact output is delivered. Full-empty calibration can be performed easily and safely.

Different designs and different solution related to industrial levelmeasurement are offered especially for machinery manufacturers.

#### Application Areas :

Liquid tanks, food machines, cooling liquid tanks, shipping, glycol tanks, brine, waste water tanks. Oil tanks, CO2 liquid tanks, high temperature tanks, non-conductive liquids. Grain stores, cement, sand feed, flour, milk powder, organic and plastic granule. Sticky hot and high viscosity liquid, acid and chemical liquids.

#### Advantages :

There are no moving parts. High pressure and temperature resistant design. Modular structure with easy assembly. Not affected by foam, liquid splashes. Not affected by vibration, has robust mechanical structure. Zero span adjustment is easy. Measurement along whole sensor. Operability with reverse assembly.

For Conductive liquids ECAP 100 series  
For Low conductive liquids ECAP 200 series  
For Solids particulate materials ECAP 300 series  
For Adhesive and acid/basic liquids ECAP 400 series

## ECAS CAPACITIVE TYPE LEVEL SWITCHES



► ECAS



► DX-ECAS



► Technical Specifications

Supply	: 24 VDC	: 24 VDC
Signal Output	: 1 NONC x 5 A / 250 VAC Relay	: 1 NONC x 5 A / 250 VAC Relay
Min. Di-Electric Constant	1,6 $\epsilon_r$	1,6 $\epsilon_r$
Connection Material	304 St.St. , Opt. 316 St.St.	304 St.St. , Opt. 316 St.St.
Isolation Material	: PTFE, PFA Opt. Peek, Ceramic	: PTFE, PFA Opt. Peek, Ceramic
Housing Material	: PBT (Std.) Opt. Aluminum Injection, St.St.	: Aluminum Injection , AISi12Fe (Std) Black
Working Pressure	: (-)1 bar...(+)100 bar (Depending on the model)	: (-)1bar...(+) 25 bar (Depending on the model)
Working Temperature	: (-) 40 °C / (+) 150 °C (Depending on the model) , 200 °C with cooling apparatus 230 °C with Peek isolation, 400 °C with ceramic isolation	: (-) 40 °C / (+) 150 °C (Depending on the model) , 200 °C with cooling apparatus 230 °C with Peek isolation, 400 °C with ceramic isolation
Ambient Temperature	: (-)20 °C...(+) 60°C	: (-)20 °C...(+) 60°C
Display	: With LED-Power and Contact LED	: With LED-Power and Contact LED
Isolation	: Max. 500 V	: Max. 500 V
Power Consumption	: Max. 1 W	: Max. 1 W
Electrical Connection	: Terminals	: Terminals
Protection Class (EN60529)	: IP 65, IP 66, IP 68	: 66, IP 68

ECAS level switch is a capacitive level sensor for level measurement of conductive liquid, nonconductive liquid, granulated materials with solid particles, adhesive and acid/basic liquids. When a material comes between electrode rod and tank wall, a capacitance change occurs and when this change exceed adjustment threshold, contact output is delivered. Designed for difficult process conditions. Refrigerated models can be manufactured for high temperature and pressure conditions. Calibrations of triggering point and relay operation range can be performed by the user under workplace conditions. It can be connected horizontally or vertically.

**Application Areas :**

Liquid tanks, food machines, cooling liquid tanks, shipping, glycol tanks, brine, waste water tanks. Oil tanks, CO2 liquid tanks, high temperature tanks, non-conductive liquids. Grain stores, cement, sand feed, flour, milk powder, organic and plastic granule. Sticky hot and high viscosity liquid, acid and chemical liquids.

**Advantages :**

There are no moving parts. High pressure and temperature resistant design. Modular structure with easy assembly. Not affected by foam, liquid splashes. Not affected by vibration, has robust mechanical structure. Zero span adjustment is easy. Measurement along whole sensor. Operability with reverse assembly.

For Conductive liquids ECAS 100 series  
For Low conductive liquids ECAS 200 series  
For Solids particulate materials ECAS 300 series  
For Adhesive and acid/basic liquids ECAS 400 series

# ECAPm / ECAPr / ECAPe

## OEM CAPACITIVE TYPE LEVEL SENSORS



### ► Technical Specifications

Measurable Material	: Conductive liquids, refrigerants Non-conductive liquids Solids particulate materials Adhesive and acid/basic liquids
Supply	: 10...30 VDC Max.35 VDC 3-330 Ohm, 3-180 Ohm, 13-1300 Ohm...
Output	: (Check that it is compatible with the supply voltage of the relay operation.)
Capacity Range	: 1 pF...3 nF
Min. Di-Electric Constant	: 1,6 $\epsilon_r$
Accuracy	: $\pm$ % 0,5 ... $\pm$ % 5 (Depending on the model)
Linearity	: % 0,5 Min 50 mm, Max. 2000 mm
Probe Length	: 304 Stainless Steel, Opt. 316 Stainless Steel
Connection Material	: Alüminium, PVDF, PTFE PFA Opt. PTFE, Delrin, Peek, Ceramic
Isolation Material	: Alüminium, Plastic
Isolation Material	: (-) 30 °C / (+) 150 °C (Depending on the model)
Working Temperature	: 200 °C with cooling apparatus 230 °C with Peek isolation
Working Pressure	: Max. 150 bar (Depending on the model)
Ambient Temperature	: (-)20 °C...(+ ) 60 °C, (-) 20 °C / (+) 80 °C
Power Consumption	: Max. 1 W, Max. 50 mW
Electrical Connection	: Terminals, Socket according to ISO 4400, Cable
Connection	: 1/2" BSP std. Thread Male (According to the order)
Max.Tensile Force	: Max. 10 Nm, 20 Nm, 40 Nm
Protection Class (EN60529)	: IP 65, IP 67

### ► ECAPm / ECAPr / ECAPe

#### Advantages :

It can be able to calibrated by customer  
There are no moving parts.  
Not affected by vibration, has robust mechanical structure.  
Measurement along whole sensor.  
High pressure and temperature resistant design.  
Easy assembly and sensitivity adjustment.  
Not affected by foam, liquid splash and probe coating..

#### Application Areas :

Liquid tanks, food machines, cooling liquid tanks, shipping, glycol tanks, brine, waste water tanks.Oil tanks, CO2 liquid tanks, high temperature tanks, non-conductive liquids.  
Grain stores, cement, sand feed, flour, milk powder, organic and plastic granule.  
Sticky hot and high viscosity liquid, acid and chemical liquids.



Conductive Liquid



Low Conductive Liquid



Solids Particulate Material



Adhesive and Acid / Basic Liquid

#### Application :





# ECASm / ECASe / ECAM

## OEM CAPACITIVE TYPE LEVEL SENSORS

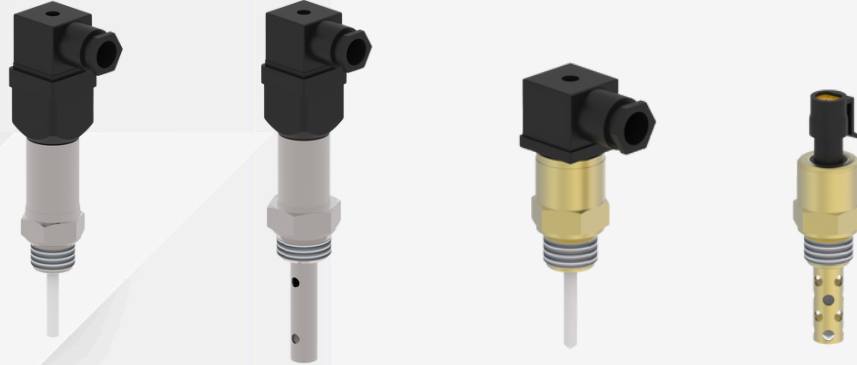

### Technical Specifications

#### ► ECASm / ECASe / ECAM

Measurable Material	: Conductive liquids, refrigerants Non-conductive liquids Solids particulate materials Adhesive and acid/basic liquids
Supply Output	: 10...30 VDC Max.35 VDC : 1 NO/NC x 5 A / 250 VAC Relay (Delay 2 sec.) NPN or PNP Open Collector Transistor NO or NC (Please specify when ordering) (Check that it is compatible with the supply voltage of the relay operation.)
Capacity Range	: 1 pF...3 nF
Min. Di-Electric Constant	: 1,6 εr
Accuracy	: ± % 0,5 ... ± % 5 (Depending on the model)
Linearity	: % 0,5 Min 50 mm, Max. 2000 mm
Probe Length	: 304 Stainless Steel, Opt. 316 Stainless Steel
Connection Material	: Aluminium, PVDF, PTFE PFA Opt. PTFE, Delrin, Peek, Ceramic
Isolation Material	: Aluminium, Plastic
Isolation Material	: (-) 30 °C / (+) 150 °C (Depending on the model)
Working Temperature	: 200 °C with cooling apparatus 230 °C with Peek isolation
Working Pressure	: Max. 150 bar (Depending on the model)
Ambient Temperature	: (-) 20 °C...(+ ) 60 °C, (-) 20 °C / (+) 80 °C
Power Consumption	: Max. 1 W, Max. 50 mW
Electrical Connection	: Terminals, Socket according to ISO 4400, Cable
Connection	: 1/2" BSP std. Thread Male (According to the order)
Max.Tensile Force	: Max. 10 Nm, 20 Nm, 40 Nm
Protection Class (EN60529)	: IP 65, IP 67

#### Advantages :

- It can be able to calibrated by customer
- There are no moving parts.
- Not affected by vibration, has robust mechanical structure.
- Measurement along whole sensor.
- High pressure and temperature resistant design.
- Easy assembly and sensitivity adjustment.
- Not affected by foam, liquid splash and probe coating..

#### Application Areas :

- Liquid tanks, food machines, cooling liquid tanks, shipping, glycol tanks, brine, waste water tanks.Oil tanks, CO2 liquid tanks, high temperature tanks, non-conductive liquids.
- Grain stores, cement, sand feed, flour, milk powder, organic and plastic granule.
- Sticky hot and high viscosity liquid, acid and chemical liquids.

#### Application :

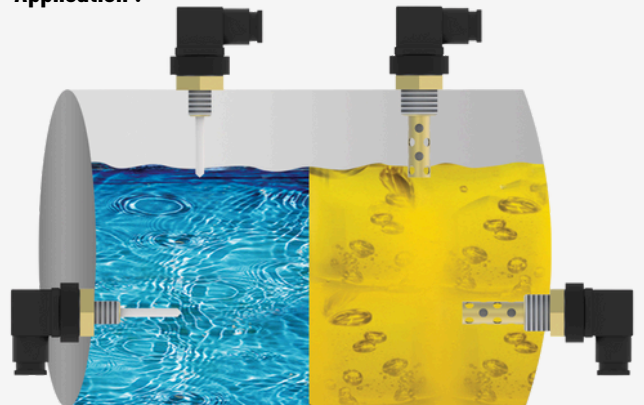

Conductive Liquid



Low Conductive Liquid



Solids Particulate Material



Adhesive and Acid / Basic Liquid

## ELS FLOAT TYPE LEVEL SWITCHES



### ► Technical Specifications

Float Material	: 316 St.St. , PU
Wetted Parts Material	: 304 St.St. (Std.) Opt. 316 St.St.
Pipe Material	: 304 St.St. (Std.) Opt. 316 St.St.
Float Type	: S4A or S40A (Std.) Selectable from Table.
Working Temperature	: Max. 85 °C , 125 °C
Mechanical Connection	: 2 " BSP (Std.) Opt. Selectable
Electrical Connection	: Terminals , With Cable, With Socket
Number of Float	: 1 (Std.) More available
Stem Length	: Max. 2500 mm (Thread Including)
Number of Contact	: 2 x SPST - NO (Std.) Opt. It can be added
Contact Current	: 1,5 A (Std.)
Max. Contact Power	: 50 W / VA
Max. Supply Voltage	: 200 VDC / 250 VAC (Std.) Opt. Selectable
Protection Class (EN60529)	: IP 65, IP 66, IP 68

### ► ELS

### ► DX-ELS

: 316 St.St. , PU
: 304 St.St. (Std.) Opt. 316 St.St.
: 304 St.St. (Std.) Opt. 316 St.St.
: S4A or S40A (Std.) Selectable from Table.
: Max. 85 °C , 125 °C
: 2 " BSP (Std.) Opt. Selectable
: Terminals , With Cable, With Socket
: 1 (Std.) More available
: Max. 2500 mm (Thread Including)
: 2 x SPST - NO (Std.) Opt. It can be added
: 1,5 A (Std.)
: 50 W / VA
: 200 VDC / 250 VAC (Std.) Opt. Selectable
: IP 66, IP 68

ELS Level sensors are used for tank level control.  
Different protection connection, material kinds are available.

#### Working Principle :

When magnetic field of magnet within the buoy moving along tube according to liquid level comes up to the reed sensor, it opens or closes the electric circuit. Such changes of reed sensors and alarm or level information can be assessed through a relay circuit or control device. It is preferred by the users because relay output is provided within the housing.

#### Advantages:

A variety of materials according to the flow  
Different choices of ignition  
Quick delivery  
Different types of technics

#### Application Areas :

Tank level measurement and control, boiler control, store room control, yacht water level control, sewage level control.  
Hydraulic oil tank level measurement and control.

#### Application :

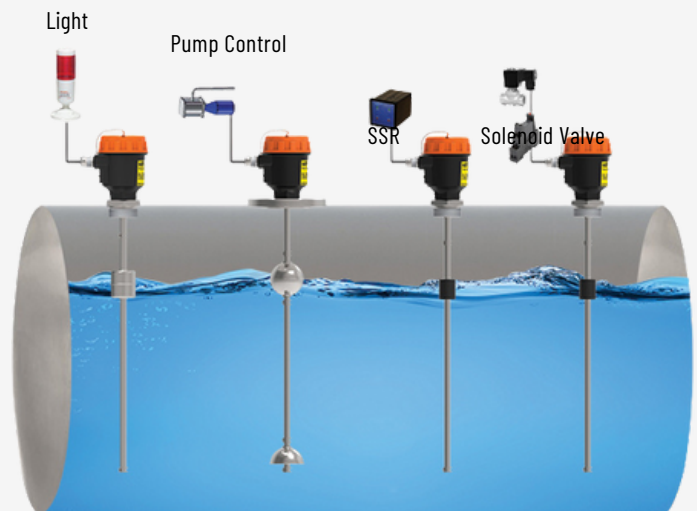

Conductive Liquid



Low Conductive Liquid



## ELS-tx FLOAT TYPE LEVEL SWITCHES



### ► Technical Specifications

Float Material	: 316 St.St. , PU
Wetted Parts Material	: 304 Stainless Steel (Std.) Opt. 316 Stainless Steel
Pipe Material	: 304 Stainless Steel (Std.) Opt. 316 Stainless Steel
Float Type	: S4A or S40A (Std.) Selectable from table
Working Temperature	: Max. 125 °C
Mechanical Connection	: 2 " BSP (Std.) Opt. Selectable
Electrical Connection	: Terminals , With Cable, With Socket
Number of Float	: 1 (Std.) More available
Stem Length	: Max. 6000 mm (Thread Including)
Supply	: 12...36 VDC
Output	: 4-20 mA (Std.) Two wires : Ops. 4-20 mA , 0-20 mA , 0-10 V , Ohm , Three wires
Frequency of Detection	: 15 mm / 10 mm / 5 mm
Protection Class (EN60529)	: IP 65, IP 66, IP 68

### ► DX-ELS-tx

: 316 St.St.
: 304 Stainless Steel (Std.) Opt. 316 Stainless Steel
: 304 Stainless Steel (Std.) Opt. 316 Stainless Steel
: S4A or S40A (Std.) Selectable from table
: Max. 125 °C
: 2 " BSP (Std.) Opt. Selectable
: Terminals , With Cable, With Socket
: 1 (Std.) More available
: Max. 6000 mm (Thread Including)
: 12...36 VDC
: 4-20 mA (Std.) Two wires : Ops. 4-20 mA , 0-20 mA , 0-10 V , Ohm , Three wires
: 15 mm / 10 mm / 5 mm
: IP 66, IP 68

ELS-tx Level sensors are used for tank level control.

#### Working Principle :

When magnetic field of magnet within the buoy moving along tube according to liquid level comes up to the reed sensor, it opens or closes the electric circuit. Continuous type serial aligned resistance and reed relays are engaged and disengaged. Such changes of reed sensors and alarm or level information can be assessed through a relay circuit or control device. Precision of reed sensor increases according to lowness of its placement range. It is preferred by the users due to the advantages of providing analogue output within the housing. Furthermore, it is possible to follow and to control the process in the field through indicator.

#### Advantages:

- A variety of materials according to the flow
- Different choices of ignition
- Quick delivery
- Different types of technics

#### Application Areas :

- Tank level measurement and control, boiler kontrol, store room control , yacht water level control, sewage level control.
- Hydraulic oil tank level measurement and control.

#### Application :

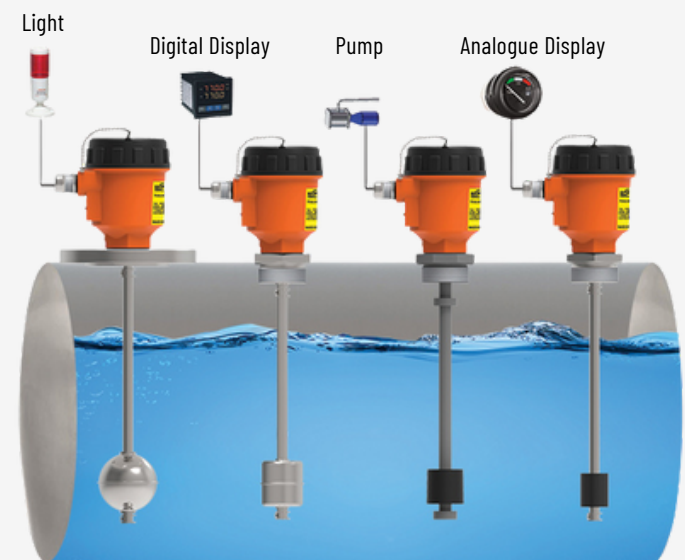

Conductive Liquid



Low Conductive Liquid



## ELB LEVEL SWITCHES - SIDE MOUNTING



### ► Technical Specifications

Mounting Type	: Horizontal, Vertical
Flange Material	: 316 Stainless Steel
Float Material	: 316 Stainless Steel
Output	: 250 V AC 12 10 A , 220 V DC 12 0.6 A 0.2 bar ... 1 bar
Min. Density	: 0.70 g/cm <sup>3</sup> ; 0.75 g/cm <sup>3</sup> ; 0.80 g/cm <sup>3</sup>
Housing Material	: Aluminum Injection , 304 Stainless Steel
Flange Dimension	: 92 mm x 92 mm , DN 65 , DN 80 , DN 100
Max. Pressure	: 16 bar , 25 bar , 100 bar
Max. Temperature	: 150 °C , 250 °C
Ambient Temperature	: (-) 20 °C / (+) 80 °C
Weight	: 1.8 kg...2.5 kg
Float Test Pressure	: 25 bar , 40 bar , 160 bar
Protection Class (EN60529)	: IP 65

### ► ELB

### ► DX-ELB

Mounting Type	: Horizontal, Vertical
Flange Material	: 316 Stainless Steel
Float Material	: 316 Stainless Steel
Output	: 250 V AC 12 10 A , 220 V DC 12 0.6 A 0.2 bar ... 1 bar
Min. Density	: 0.70 g/cm <sup>3</sup> ; 0.75 g/cm <sup>3</sup> ; 0.80 g/cm <sup>3</sup>
Housing Material	: Aluminum Injection , 304 Stainless Steel
Flange Dimension	: 92 mm x 92 mm , DN 65 , DN 80 , DN 100
Max. Pressure	: 16 bar , 25 bar , 100 bar
Max. Temperature	: 150 °C , 250 °C
Ambient Temperature	: (-) 20 °C / (+) 80 °C
Weight	: 1.8 kg...2.5 kg
Float Test Pressure	: 25 bar , 40 bar , 160 bar
Protection Class (EN60529)	: IP 66, IP 68

ELB level switches are used for measuring and checking level of tank. It is preferred in food, ship machine, boiler and storage tank applications with its advantages such as resistance to high temperature, long life contact structure, which is operable in each, vertical or horizontal connection.

#### Working Principle :

Microswitch changes direction with the movement, occurring after magnet in float arm, moving by changing liquid level, affects magnet inside body, magnetically obtained contact information is assessed by transferring into applications such as pump, solenoid valve etc.

#### Advantages:

- Max. 100 bar working pressure
- Max. 250 °C working temperature
- The apparatus diversity

#### Application Areas :

Food, ship, machine, boiler and storage tanks, hydraulic oil tanks, waste water tanks.

#### Accessories:



Bellows Apparatus



Counter Flange

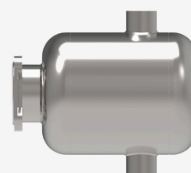

External Tank

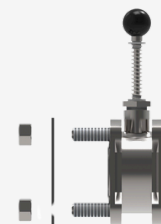

Test Apparatus



Conductive Liquid



Low Conductive Liquid

# ELG MAGNETIC BY-PASS LEVEL INDICATORS



EN ISO3834-2



► Technical Specifications

Magnetic Display

Max.Working Pressure

Max.Working Temperature

Top / Bottom / Side

Flange

Body

Seal Material

Side Pipe Material

Connection Flange

Drain Screw Material

Bolt / Nut / Washer

Optional

► ELG

- : It is composed of sequential array of magnet sensitive flaps in the aluminium profile.
- : 16 bar, 25 bar, 40 bar, 100 bar
- : 180 °C, Ops. 350 °C, 60 °C
- : DN 32 / PN 16, 304 St.St. Opt.316 Stainless Steel
- : Ø 140 / PN 40 , 304 St.St. Opt.316 Stainless Steel
- : Ø 195 / PN 100 , 304 St.St. Opt.316 Stainless Steel
- : Ø 60.3 x 1,5 / 2 / 3 / 3,5 mm, 304 St.St. Opt. 316 Stainless Steel
- : Ø 63 x 3 mm, PVC
- : Ø 63 x 2 mm, Titanium
- : Klingrid Opt. PTFE , Graphite
- : 304 St.St. Opt. 316 St.St. / PVC
- : DN 20 / PN 16, Carbon Steel Opt. 304 / 3016 St.St. / PVC / Titanium
- : 1/2" BSP 304 / 316 St.St.
- : M 12 x 45 mm / M 16 x 70 mm 304 Stainless Steel
- : Magnetic Contact
- Analog Output , Scale , Drain Valve
- Liquid Level Relay , Local Digital Display
- Heating Jacket, Special Design

**Advantages:**

- For visual monitoring and control
- The analog signal can be output
- Different connection options
- Different material options
- Local digital display



ELG magnetic by-pass level indicators are assembled into external or upper surfaces of tank, boiler and storage tanks. It enables to see level easily and with high accuracy. It is more economic than other measurement systems with mechanical method and it provides advantages for user with various assembly forms together with easy of assembly and maintenance.

**Working Principle :**

Liquid levels are the same in the main body of tank and level indicator in accordance with the principle of computational fluid. Float, which is available in the body and provides its rotation. Liquid level can be monitored easily from outside by means of two faces of flaps with different colors. Each indicator is delivered to customer after they are undergone from pressure, impermeability and final control tests after the production.

**Application Areas :**

Food, ship, machine, boiler and storage tanks, hydraulic oil tanks, waste water tanks.



Conductive Liquid



Low Conductive Liquid

## ELG ACCESSORIES



CE 2284

### ► Technical Specifications

### ► MAGNETIC CONTACT - DX-ELG-K4

Contact Element	: Reed Sensor SPST-NO Hold Type	: Reed Sensor SPDT-NO/NC	: Reed Sensor SPDT-NO	: Reed Sensor SPDT-NO/NC (Std.)
*Contact Current	: 1,5 A	: 1 A	: 1 A	: 1 A
*Max. Contact Power	: 20 W / VA	: 20 W / VA	: 20 W / VA	: 20 W / VA
*Max.Switching Voltage	: 200 VDC / 250 VAC	: 150 VDC / 140 VAC	:	:
Case Material	: Aluminium, ALSi2Fe Black (RAL 9005)	: Aluminium, ALSi2Fe Black (RAL 9005)	: Aluminium, ALSi2Fe Black (RAL 9005)	: Aluminium, ALSi2Fe Black (RAL 9005)
Electrical Connection	: Terminal	: Terminal	: Terminal	: Terminal
Clamp Material	: 304 Stainless Steel	: 304 Stainless Steel	: 304 Stainless Steel	: 304 Stainless Steel
Operation Temperature	: (-) 20 °C...(+) 145 °C	: (-) 20 °C...(+) 145 °C	: (-) 20 °C...(+) 145 °C	: (-) 20 °C...(+) 145 °C
Working Temperature	: (-)40 °C...(+)60 °C	: (-)40 °C...(+)60 °C	: (-)40 °C...(+)60 °C	: (-)40 °C...(+)60 °C
Protection Class (EN60529)	: IP 66 / 68 It's attached to body clamp	: IP 66 / 68 It's attached to body clamp	: IP 66 / 68 It's attached to body clamp	: IP 66 / 68 It's attached to body clamp

### ► Technical Specifications

### ► TRANSMITTER - DX-ELG-T9

Housing	: Aluminium
Tube Material	: 304 Stainless Steel
Min. Measure.Distance	: 15 mm or 10 mm or 5 mm
Power Supply	: 10...36 VDC
Output	: 2 Wire 4-20 mA, 3-180, 10-180, 240-33 Ohm Opt. HART 3 Wire 4-20 mA, 0-20 mA, 20-4 mA, 20-0 mA, 0-10 V, 10-0 V, 1-5 V, 5-1 V, 0-5 V, 5-0 V
Clamp material	: 304 Stainless Steel
Electrical Connection	: Terminal
Operation Temperature	: (-) 20 °C...(+) 145 °C
Protection Class (EN60529)	: IP 66 / 68
Working Temperature	: (-) 40 °C...(+) 40 °C It's attached to body clamp

DX-ELG series ex-proof magnetic contact and transmitter are used with magnetic level indicator. It can be used comfortably in environments that cause corrosion or high temperatures. Because, it does not have to contact with the liquid.

#### Working Principle :

Due to the reed relay and electronic circuit inside, DX-ELG series ex-proof magnetic contact and transmitter work with the magnetic field created by the float inside the magnetic level gauges. For this reason, they are mounted in the bodies of magnetic level gauges.

#### Advantages :

Economic  
Short delivery time  
Easy montage



## EMT MAGNETOSTRICTIVE LEVEL TRANSMITTERS



### ► Technical Specifications

Material to Measure	: Liquid
Power Supply	: 24 VDC ±10%
Output	: 0...10V, 4...20mA, 0...20mA, 10...0V, 20...4mA, 20...0mA
Resolution	: 16 bit DAC Output ±0,02% Full Measurement (Min. 100 µm)
Repeatability	: ±0,005% Full Scale
Measuring Length (L)	: 100...5000mm
Velocity	: < 10m/s
Sampling	: 2 kHz (Value can change by stem length.)
Max. Consumption	: 50mA -90mA (Value can change by stem length.)
Max. Output Noise	: < 5 mVpp
Max. Output Value	: 10.5 V
Update Time	: 0,5 ms...1000 m / 0,8 ms...2000 m
Permissible Applied Voltage	: Available (up to -30 VDC)
Over Voltage Protection	: Available (up to 40 VDC)
Connection (R)	: M18 x 1,5 mm Std.
Housing Material	: Aluminium
Connection Material	: 304 Stainless steel Std.
Pipe Material	: 304 Stainless steel Std.
Electrical connection	: Cable, M12-5Pin Socket
Protection Class (EN 60529)	: IP 66
Test	: EMC , Low Voltage
Mak. Tencile Force	: Max. 40 Nm
Working Temperature	: Max. 125 °C Opt. 150 °C
Working Pressure	: Max. 30 bar
Ambient Temperature	: (-)20°C / (+) 60°C

### ► EMT

#### Advantages :

- High accuracy / precision ( 16 bit)
- Long-working use
- Short response time
- Output signal options
- Easy setup
- IP66 Protection class

#### Application Areas :

- Fuel Industry :** Gasoline, diesel and liquid natural gas applications
- Chemical Liquid Facilities :** Pharmaceutical industries, biological engineering and similar chemical liquid mixing tanks
- Water Management Facilities :** Dam, Waste water sanitation facilities for real time monitoring
- Food and Beverage Facilities :** High sensitivity level monitoring for tanks contains liquid

EMT Magnetostriuctive Level Transmitter is a float type level sensor to be used measuring the level of liquids; designed especially for the difficult processes. Mounts vertically and can locate the very middle point of two opposite magnetic force fields by emitting signals. Therefore, no calibration or adjustment will be needed after the first set, even with the power cuts.

Furthermore, it's sensing element is in the body which prevents the wearing effects of the usage, sustains long term durability by avoiding the physical contact.





## ELH REFLEX GLASS TYPE LEVEL INDICATORS



### ► Technical Specifications

Body Material	: Carbon Steel, Stainless Steel
Glass Material	: Borosilicate Glass
Cushion Gasket Material	: Klinger-sil14430, Graphite
Bolt Material	: Carbon Steel (6.8 x 8.8), Stainless Steel
Connection	: Flanged According to EN1092-1
Pressure Class	: PN 16, PN 40
Axis Dimension	: 300 mm...2500 mm
Max. Temperature	: 200 °C Opt. 300 °C
Test Pressure	: x 1,5

### ► ELH

#### Advantages:

- Economical
- Easy to read
- Can be used in high pressure steam

#### Spare Parts:

- Valves
- Glass
- O-Rings
- Glass seals

Reflex glasses are used for observing level in pressure tanks and high temperature liquids.

#### Working Principle :

Light refraction is different between liquids and gases. Liquids shows dark color due to absorption of light, however air and vapor shows bright color due to reflecting light. Reflex glasses do not get affected from thermal shocks and static temperature differences. It is not applicable( appropriate ) for liquids that can harm the glass. (e.g. high temperature alkaline solutions and hydrofluoric acid )

#### Application Areas :

Steam tanks, loading-dumping tanks, chemical industry, petroleum product tanks, hygienic load tanks, fuel depots.



Conductive Liquid



Low Conductive Liquid

## ELF ROTARY LEVEL SWITCHES



EAC CE

### ► Technical Specifications

### ► ELF

Working Temperature	: (-) 20 °C.....(+) 90 °C Opt. Max.150 °C With High Temperature Type (Plastic Housing) Max. 200 °C With High Temperature Type (Aluminium Housing) Max. 600 °C Very High Temperature Type
Ambient Humidity	: 0-98 % Rh (Non Condensate)
Ambient Temperature	: (-) 20 °C ... (+) 60 °C
Working Pressure	: (-) 0,6 bar... (+) 0,6 bar
Material Connection	: Aluminium (Std) Opt. 304 / 316 St. St., PTFE
Housing	: Antistatic Plastic (Std) Opt. Aluminium Enjection - AISi12Fe (Std) Body : Black Cover : Orange
Paddle And Rode	: 304 St. St. ( Std) Opt. 316 St. St.
Extension Pipe	: 304 St. St. ( Std) Opt. 316 St. St.
Grounding Apparatus	: 304 St. St.
Seal for Cover	: Elastomer Thermoplastic 120 °C (Std) Ops. FPM (Viton) 150 °C
Bearing	: Double ball bearing (With Dust-protected)(120 °C) Ops. 280 °C
Dust Protected Felting	: NBR (Std) Opt. FPM (Viton) 150 °C, PTFE 200 °C
Connection	: 1" BSP (Std) , Opt. 1 1/4" BSP , 1 1/2" BSP Male Thread
Power Consumption	: Max. 4 W
Revolutions Per Minute	: 5 Rpm (Std) (Clockwise - When Looking Paddle Side) Opt. 1,5-1,8 Rpm
Power Supply	: 24 VDC , ± 10 , 24 / 110 / 220 VAC 50/60 Hz ±% 10
Cable and stopper input	: PG 13.5 (Std) Opt. M 20 x 1,5 mm <sup>2</sup>
Relay switching capacity	: 2 A / 250 VAC 2 x NO/NC (SPDT) 5E4 Opt. 10 A / 250 VAC - 4A/30VDC
LED	: Power LED: Green , Alarm LED: Red
Max. Grain Structure	: 50 mm
Min. Density	: 0,04 g/cm <sup>3</sup> (According to paddle type)
Torque Rating	: 4 Stages, adjustable
Load on probe	: Max. 500 N (Extention Pipe)
Protection Class (EN60529) IP 66	: IP 65, IP 66



### Application Areas :

**Plastic Industry ;** PVC, PVDF, PP granular etc..

**Food Industry ;** Grain Dust, Ground Corn, Sugar-Granulated, Cacao, Malt-Graoung Dry, Sunflower Corn, Whead, Peanuts-Shelled, Clays- Kaoline, Talcum Powder, Ground-Paprika, Coffee-Roasted vb..

**Build Industry ;** Rocks-Limestone Crushed, Lime, Cement Powder, Rubber Ground, Lime Hydrate Dust, Calsium Dust, Iron Chips, Silica Sand, Moulding Sand, Styrofaam etc..

**Wood Industry ;** Wooden Fiberst, Saw Dust etc.. Other Chemistry Industry ; Coal Lump, Ash-Coal Dry etc..



## DX-ELF ROTARY LEVEL SWITCHES



### ► Technical Specifications

### ► DX-ELF

Working Temperature	: (-) 20 °C.....(+) 90 °C (-) 20 °C.....(+) 60 °C Opt. Max.150 °C With High Temperature Type Max.200 °C With High Temperature Type
Ambient Humidity	: 0-98 % Rh (Non Condensate)
Ambient Temperature	: (-) 20 °C ... (+) 60 °C
Working Pressure	: (-) 0,6 bar... (+) 0,6 bar
Material Connection	: Aluminium (Std) Opt. 304 / 316 St. St.
Housing	: Aluminium Enjection - AISi12Fe (Std) Black
Paddle And Rode	: 304 St. St. ( Std) Opt. 316 St. St.
Extension Pipe	: 304 St. St. ( Std) Opt. 316 St. St.
Grounding Apparatus	: 304 St. St.
Seal for Cover	: Elastomer Thermoplastic 120 °C (Std) Ops. FPM (Viton) 150 °C
Bearing	: Double ball bearing (With Dust-protected) (120 °C) Ops. 280 °C
Dust Protected Felting	: NBR (Std) Opt. FPM (Viton) 150 °C, PTFE 200 °C
Connection	: 1" BSP (Std) , Opt. 1 1/4" BSP , 1 1/2" BSP Male Thread
Power Consumption	: Max. 4 W (220 VAC) , Maks. 3 W (24 VDC)
Revolutions Per Minute	: 5 Rpm (Std) (Clockwise - When Looking Paddle Side) Opt. 1,5-1,8 Rpm
Power Supply	: Power Supply 24 VDC ± %10 , 24 / 48 / 110 / 220 VAC 50/60 Hz ± %10
Cable and stopper input	: M 20 x 1,5 mm <sup>2</sup> (Std)
Relay switching capacity	: 10A/250 VAC - 4A/30VDC 2x NO/NC (SPDT) 5E4
LED	: Power LED: Green , Alarm LED: Red
Max. Grain Structure	: 50 mm
Min. Density	: 0,04 g/cm <sup>3</sup> (According to paddle type)
Torque Rating	: 4 Stages, adjustable
Load on probe	: Max. 500 N (Extention Pipe)
Protection Class (EN60529)	: IP 66, IP 68



Solids Particulate Material

### Application Areas :

**Plastic Industry ;** PVC, PVDF, PP granular etc..

**Food Industry ;** Grain Dust, Ground Corn, Sugar-Granulated, Cacao, Malt-Graoung Dry, Sunflower Corn, Whead, Peanuts-Shelled, Clays- Kaoline, Talcum Powder, Ground-Paprika, Coffee-Roasted vb..

**Build Industry ;** Rocks-Limestone Crushed, Lime, Cement Powder, Rubber Ground, Lime Hydrate Dust, Calsium Dust, Iron Chips, Silica Sand, Moulding Sand, Styrofaam etc..

**Wood Industry ;** Wooden Fiberst, Saw Dust etc.. Other Chemistry Industry ; Coal Lump, Ash-Coal Dry etc..



## ELM FLOAT TYPE LEVEL SWITCHES



### ► Technical Specifications

Float Material	: 304 St.St. , 316 Stainless Steel , PP
Wetted Parts Material	: 304 Stainless Steel , 316 Stainless Steel
Pipe Material	: 304 Stainless Steel , 316 Stainless Steel
Float Type	: S1Y , S3Y , S2A, S4A , S5A , S40A , P81
Working Temperature	: Max. 125 °C
Mechanical Connection	: 1/8" BSP , 3/8 " BSP , 1/2" BSP , 3/4" BSP
	: M 10 x 1 mm <sup>2</sup>
	: 5 bar , 10 bar , 30 bar
Max. Pressure	: 0.70 g/cm <sup>3</sup> , 0.75 g/cm <sup>3</sup> , 0.85 g/cm <sup>3</sup>
Min. Density	: Cable , Socket
Electrical Connection	: 1 Std.
Number of Float	: 1 x SPST-NO , 1 x SPDT-NO / NC
Number of Contact	: 0.7 A , 1 A , 1,5 A
Contact Current	: 10 W / VA , 50 W / VA
Max. Contact Power	: 200 VDC / 140 VAC
Max. Supply Voltage	: 180 VDC / 130 VAC
	: 200 VDC / 250 VAC
Optional	: Liquid Level Relay SK-P2

### ► ELM

### Advantages:

- Economic.
- Practical and easy installation.
- Fast delivery.
- Stainless steel material.



Conductive  
Liquid



Low Conductive  
Liquid

ELM level switches are used for checkin level of tank. It is preferred by machine manufacturers, especially in terms of its ease of use and economy. The ELM level switched can be mounted in litte places because of their mini design. The switches are made by.

### Working Principle :

When magnetic field of magnet in the float is aligned with reed sensor in the tube , it opens or closes the electric circuit.

When float moves away , sensor reverts back (upon demand , drawn contact may be made). Level information can be assessed with a relay circuit.

### Application Areas :

Machines, tanks, boilers, gas and liquid mediums, level measuring, temperature measuring...

### LEVEL CONTROL DEVICE

Power Supply	: 220 VAC, 2.8 VA
Output	: 2 pcs. 5 A / 250 VAC Relay (Start/Stop)
Working Temperature	: (-) 20 °C...(+) 70 °C
Dimensions	: 72 x 72 mm
Input	: Contact information come from ELM
Isolation	: Input and output are isolated



SK-R  
72mm x 72 mm

## ELP FLOAT TYPE LEVEL SWITCHES

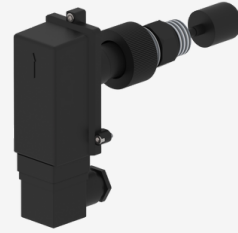
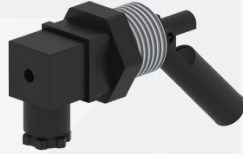

### ► Technical Specifications

### ► ELP

Float Material	: PP , NBR , PVDF , Delrin
Wetted Parts Material	: PP , PVDF , Delrin
Pipe Material	: PP , PVDF , Delrin
Working Temperature	: (-) 20 °C / (+) 80 °C , (-)40 °C / (+) 80 °C , (-) 30 °C / (+) 120 °C
Max. Pressure	: Atm. , 2 bar , 4 bar , 10 bar
Min. Density	: 0.70 g/cm <sup>3</sup> , 0.75 g/cm <sup>3</sup> , 0.75 g/cm <sup>3</sup>
Electrical Connection	: Cable , Socket
Number of Float	: 1 Std.
Number of Contact	: 1 x SPST-NO , 1 x SPDT-NO / NC
Contact Current	: 0,7 A , 1 A , 1,5 A
Max. Contact Power	: 10 W / VA , 50 W / VA
Max. Supply Voltage	: 180 VDC / 130 VAC , 200 VDC / 140 VAC , 500 VDC / 350 VAC

### Advantages:

- Economic.
- Practical and easy installation.
- Fast delivery.
- PP material.

ELP level switches are used for checking level of tank. It is preferred by machine manufacturers, especially in terms of its easy of use and economy.

The ELP level switch can be mounted in little places because of their mini design. The switches are made by stainless steel material and so can be used in various liquids.

### Working Principle :

When magnetic field of magnet in the float is aligned with reed sensor in the tube, it opens or closes the electric circuit.

When float moves away, sensor reverts back (upon demand, drawn contact may be made). Level information can be assessed with a relay circuit.

### Application Areas :

Machines, tanks, boilers, gas and liquid mediums, level measuring, temperature measuring...

### E-GSM Alarm Device - Double Entry

Battery or and supply  
2 pcs. Lithium batteries,  
12V adaptor (Included)  
Excluding phone card.

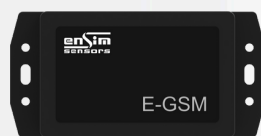

Conductive  
Liquid



Low Conductive  
Liquid

## ELC LEVEL SWITCHES - Conductivity Type

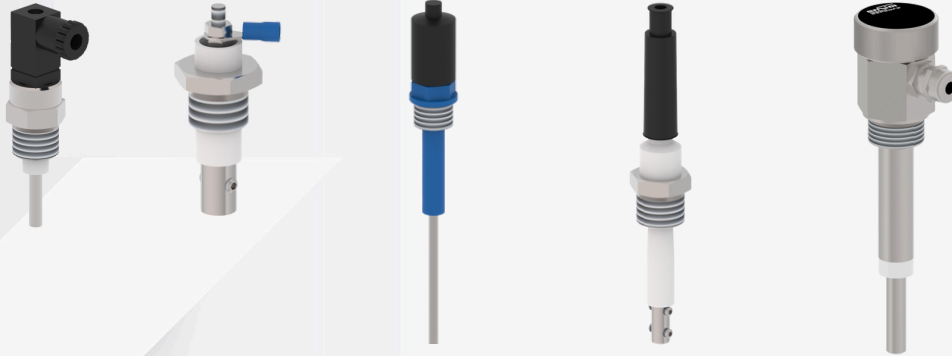

### ► Technical Specifications

Electrode Material	: 304 Stainless Steel , Opt. 316 Stainless Steel
Isolation of Electrode	: Special Tubing , PTFE , PBT , PVDF, Delrin
Connection Material	: 304 St.St , 316 St.St , PTFE , PBT, Delrin
Housing	: 304 St.St, 316 St.St , PTFE , PBT, Delrin
Max. Working Temp.	: 60 °C , 80 °C , 100 °C ,120 °C , 200 °C , 225 °C
Max. Working Pressure	: 6 bar , 10 bar , 25 bar , 30 bar , 40 bar
Voltage Probe	: Max. 6 VAC
Mechanical Connection	: 1 /4" BSP , 1 /2" BSP / NPT , 1" BSP
Electrical Connection	: PG 7 , PG 13.5 , Terminals , Socket

### ► ELC

#### Working Principle :

When liquid level comes to the level of isolated electrode, current passage starts or stops between electrode and liquid. Strengthened this AC current may be assessed with a relay circuit.  
ELC level switches are used for checking liquid level of tanks and boilers. As it does not have any movable part, it can be used in the critical ambient and in the liquids with solid particle, low density and high viscosity.

#### Advantages:

- Economical
- Easy to install
- No moving parts

#### Application Areas :

It is an economic and safe solution for air pressure tank applications, water level control of steam boilers and conductive tanks.



Conductive Liquid



Low Conductive Liquid

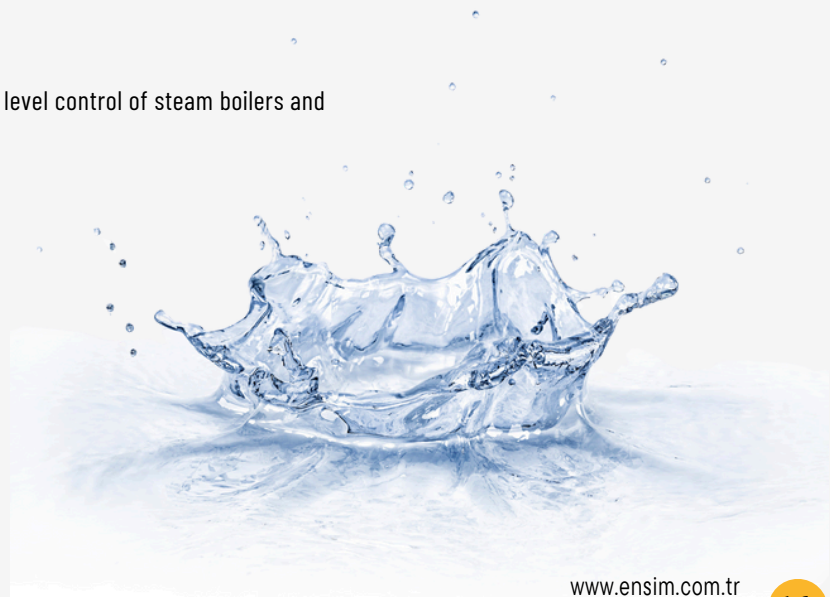



## ISS LEVEL SWITCHES - Conductivity Type ELC LEVEL SWITCHES - Conductivity Type



### ► Technical Specifications

### ► ISS

### ► ELC

Mounting Position	: Vertical (into boiler or with by-pass tube)
Process Connections	: 1" BSP , 2" BSP
Working Pressure / Temperature	: Max. 32 bar , Max. 238 °C , 6 bar, 10 bar, 25 bar..
Housing	: PC, Aluminum Casting (Electrostatic Painted)
Connection Material	: 316 Stainless Steel
Electrode Isolation	: Special Tubing, PTFE, PBT, PVDF, Delrin
Pipe Part	: PTFE
Electrode Material	: 304 Stainless Steel, 316 Stainless Steel
Pipe Material	: 304 Stainless Steel, 316 Stainless Steel
Electrode Length	: 500 mm , 1000 mm , 1500 mm
Electrode Diameter	: 4 mm
Cable	: 5x0.75 mm <sup>2</sup> With Silicon Insulated
Cable Entry	: 3 pcs. PG 11 Chromed Brass, PG7, PG13,5, Socket
Supply	: 220-240 VAC (Std.) or 24 VDC (Opt.) , 2 VA
Electrode Voltage	: Max. 6 VAC
Sensitivity	: 1 uS/cm min. or 30 uS/cm min. selectable
Output Contact Current	: 4 x 8 A / 250 VAC
Relay Delay	: 3 sec.
Ambient Temperature	: 70 °C
Protection Class (EN60529)	: IP 65

ISS Level Sensor is designed for controlling of conductive measurement principle. It has four different measurement probe and an electronic unit and so without any other control unit it allows to control by itself. The sensor has two different conductive level measurement and four different control function, which are selectable by user. It can be used in min.1 µS/cm and over conductive liquids.

#### Advantages:

- Compact structure.
- Multi-function can be controlled.
- Wetted parts is 316 stainless steel.
- Low conductivity liquids can be worked.

#### Application Areas :

It is an economic and safe solution for air pressure tank applications, water level control of steam boilers and conductive tanks.  
Degasifier , Steam boilers, Condansate tanks , Conductive liquid tanks...



Conductive Liquid



Low Conductive Liquid

# WATERSENS / OILSENS LIQUID WARNING DEDECTOR



## ► Technical Specifications

Display	: 3 each Alarm LED
Siren	: 1 each Siren + On / Off Button
Sensor	: Bipolar Cable, 1 m. Std. Three sensors can connect devices
Supply	: 9 V Square Alkaline Battery or 24 VDC
Output	: 2 A / 125 VAC NO / NC
Battery life	: 2 years for storage
Housing	: ABS Plastic, Black Colour (Opt.Grey) (Inbox; 1 each watersens and probe 1 each Battery, 1 each Double-sided tape 2 each Wall mounting bracket)
Weight (With package)	: 190 g.
Dimenson	: 70 mm x 100 mm x 22 mm

## ► WATERSENS

## ► Technical Specifications

Supply	: 18-29 VDC
Cable	: 3 x 0.22 mm <sup>2</sup> or 5 x 0.22 mm <sup>2</sup> , 2 m.Std.
Output	: PNP-NO / NC Max. 100 mA NPN-NO / NC Max. 100 mA RELAY-NO / NC Max. 300 mA In order to be indicated.
Connection	: 3/4" NPT Double Sided
Body Material	: PP Opt. Stainless Steel
Working Temperature	: Max. 85 °C
Working Pressure	: Max. 20 bar
Mounting	: Connected Vertically or Horizontally
Protection Class (EN60529)	: IP 68
Min. Conductivity	: 100 microSiemens / cm

## ► OILSENS

Watersens is used in order to detect the flood in advance and to take precaution at homes and offices. It can be powered by 9V. battery.

It can be ensured to stop any water leakage by commanding relay output to a solenoid valve. It can avail people around it to take precautions by attracting their attention through siren.

WATERSENS P / N / R is used in order to determine the water level and to take precaution in the facilities. It ensures the people in the ambient to take precaution by attracting their attention through siren in order to determine high water or low water level.

Its electronic card is in the upper box and it is insulated with resin. It is not affected by water.

Electrode material has been selected as stainless steel and its electronic design has been performed specially in order that there is no electrolysis in the lead terminals.

It is appropriate to submerge a weight onto the tooth on the submersion probe.

### Application Areas :

Operation rooms, computer rooms, warehouses, generator rooms, compressor rooms, air conditioner rooms, baths, kitchens and all locations having possibility of flood, fire alarm systems, wells, for high water detection, ship tanks, water level control, water leakage.



Conductive Liquid



Low Conductive Liquid

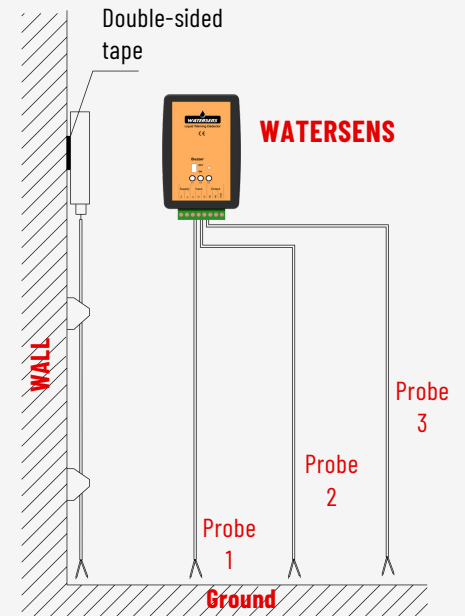

## ELW RADAR TYPE LEVEL TRANSMITTERS



### ► Technical Specifications

	► ELW 101	► ELW 102
Material to Measure	: Liquid, Solid Particulate Materials, Aggressive Liquids	: Liquid, Solid Particulate Materials, Aggressive Liquids
Range	: 0...20 m	: 0...10 m / 20 m / 30 m / 70 m
Accuracy	: <± 2 mm	: <± 3 mm <± 5 mm
Settings Menu Language	: English	: English
Sensitivity	: ± 3 mm	: ± 3 mm
Repeatability	: ± 1,5 mm	: ± 1,5 mm
Resolution	: 1 mm	: 1 mm
Frequency	: 26 GHz / 80 GHz	: 26 GHz / 80 GHz
Dielectric Constant (e)	: Min. 1,4 (Selectable five different way.)	: Min. 1,4 (Selectable five different way.)
Response Time	: < 2 sec	: < 2 sec
Sampling Frequency	: 54 GHz	: 54 GHz
Indicator and Adjustment	: LCD Display	: LCD Display
Cable Input	: M20x1,5mm	: M20x1,5mm
Electric Connection	: Terminal	: Terminal
Process Connection	: G 1½" (Std.) , G 3"	: G 1½" (Std.) , G 3"
Antenna Type	: Rod Type	: Horn Type
Antenna Material	: PTFE, 316L Stainless Steel	: PTFE, 316L Stainless Steel
Housing Material	: Aluminum Injection AISi2Fe Black (RAL9005) (Std)	: Aluminum Injection AISi2Fe Black (RAL9005) (Std)
Connection Material	: 304 /316 Stainless Steel	: 304 /316 Stainless Steel
Working Temperature	: (-) 40 °C...85 °C	: (-) 40 °C... (+) 150 °C Opt. 250 °C
Ambient Temperature	: (-) 20 °C...60 °C	: (-) 20 °C...60 °C
Relative Humidity	: < % 95	: < % 95
Working Pressure	: (-) 0,8 bar... (+) 3 bar	: (-) 1 bar... (+) 40 bar
Beam Angle	: 20 °	: 18 ° / 12 ° / 8° / 6°
Supply Voltage	: 15...36 VDC 2 Wires Version	: 15...36 VDC 2 Wires Version
Power Absorption	: < 0,5 W	: < 0,5 W
Output Signal	: 4-20 mA 2 Wires + HART (Resolution 1,6 mikro A)	: 4-20 mA 2 Wires + HART (Resolution 1,6 mikro A)
Error Signal	: 20.5 mA; 22 mA ; 3,9 mA (Adjustable)	: 20.5 mA; 22 mA ; 3,9 mA (Adjustable)
Integration Time	: 0... 20 s., Programmable	: 0... 20 s., Programmable
Weight	: ~ 2 ... 4 kg	: ~ 2 ... 4 kg
Protection Class (EN60529)	: IP 66	: IP 66

### Advantages :

Compact structure , Easy to setup , Durable mechanical construction , High temperature models available.

### Application Areas :

Almost for all liquids and solid particules. Especially with abrasive/aggressive liquid level measurement applications.

Such as ; Chemical, and pharmaceutical industries, food and plastic industries, power plants, oil and cement factories. Water, acid and oil tanks, Cement and klin silos. Grain and livestock feed silos. Fire water tanks, rivers, waste material and waste water applications.



## ELW 3D PRO



### ► Technical Specifications

### ► ELW 3D PRO

Frequency	: 120 GHz - 140 GHz
Application	: Bulk solids, grains , powders
Measuring Range	: 20....120 meter
Measurement accuracy	: level accuracy $\pm 2$ mm;
Beam angle	: 3D modeling 1%...5%
Horizontal rotation	: 1.5°
angle range	: 0...360 °
Horizontal step angle	: 1 ° (adjustable)
Pitch measurement angle	: single direction
Pitch step angle	: -90 °...90 ° (settable)
Power supply	: 1 ° (adjustable)
Consumption	: 24VDC
Process temperature	: 8W
Process pressure	: -40 ° C~75 ° C
Process connection	: 0...1bar
Communication	: $\geq$ flange DN200
Signal output	: MODBUS RS485;Ethernet; FDDI;4G;5G
Housing material	: 4...20mA, RS485, MODBUS TCP, OPC,Web API
Protection	: 6061 Aluminium alloy or Nylon
Dimension	: IP67
Weight	: 308.50×185mm
	: 5Kg



ELW 3D PRO radar level scanner integrated with technology of image processing, big data analysis, AI artificial intelligence, machine learning, 3D points cloud conversion and 3D modeling, cloud storage and computing. ELW 3D PRO radar level scanner accurately detect the 3D information of solid materials and buildup on the wall of the silos. Integrated with technology of image processing, big data analysis, AI artificial intelligence, machine learning, 3D points cloud conversion, 3D modeling and cloud storage it solves the key problems of material storage and level measurement, making material management intelligent and visible. ELW 3D PRO radar level scanner brings customers Faster, Safer and Smarter process Control.



Conductive  
Liquid



Low Conductive  
Liquid



Solids Particulate  
Material

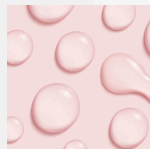

Adhesive and  
Acid / Basic Liquid

# EGW GUIDED RADAR (TDR) LEVEL TRANSMITTERS



## ► Technical Specifications

## ► EGW

Material to Measure	: Liquid, Solid Particulate Materials, Aggressive Liquids
Range	: 32 m. Wire Rope Probe 6 m. Rod Probe 4 m. Coaxial Probe
Settings Menu Language	: English
Sensitivity	: $\pm 3$ mm
Repeatability	: $\pm 1,5$ mm
Resolution	: 1 mm
Working Temperature	: (-)1...(+)40bar , Opt. Max. 100bar
Çalışma Sıcaklığı	: (-)40...(+)200°C , Opt. Max. 450°C
Ambient Temperature	: (-)20...(+)60°C
Frequency	: 106 MHz - 1,8 GHz
Dielectric Constant ( )	: Min. 1,4 (Selectable five different way.)
Response Time	: <2 sec
Sampling Frequency	: 16 Hz
Power Absorption	: <0,5 W
Supply Voltage	: 15...36 VDC 2 Wires Version (Resolution 1.6 micron A)
Output Signal	: 4-20mA 2 Wires + HART
Error Signal	: 20,5 mA , 22mA , 3,9 mA (Adjustable)
Maks. Load Resistance	: 500 W
Damping Time	: 0...90 sn.
Housing Material	: Aluminum Injection AlSi2Fe Black (RAL9005)
Connection and Insulation Material	: 304 Stainless Steel (Std.) , Opt. 316 Stainless Steel : PTFE (Std.) , Opt. PEEK , Ceramic
Indicator and Adjustment	: LCD Display
Cable Entry	: M20 x 1,5 mm
Electrical connection	: Terminal
Protection Class	: IP66 (EN60529)
Weight	: EGW 205, (For L = 1000mm) ... kg

### Advantages:

- Compact structure
- Easy to setup
- Durable mechanical construction
- High temperature models available

### Areas of Application :

- Volatile liquids, foamy liquids,
- viscous liquids, boiling and
- foaming liquids, crude oil tanks.

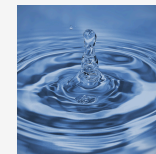

Conductive Liquid



Low Conductive Liquid

### Working Principle:

High frequency microwave pulses are guided along a steel rope or rod. When they reach the product surface, the reflected waves are detected by the electronics. The flight time of the signal (between sending and detecting time) is directly proportional to the level.

The Guided Radar Level Transmitter is used for continuous level measurement of liquids and solids. There are models that can be used in difficult working conditions. It provides reliable and accurate measurement in case of dust and noise, without being affected by accumulation and condensation. Measurement is not affected by specific gravity of the medium, condensation, fluctuation and variation of the dielectric constant (in the setting range). It has easy and simple use. It can be configured with 4 buttons on LCD display.

# ELT - DX-ELT VIBRATING ROD TYPE LEVEL SWITCHES

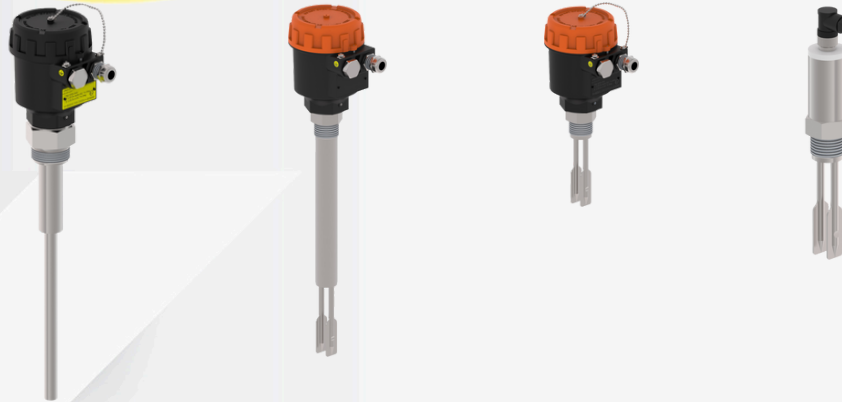

## ► Technical Specifications

## ► ELT - DX-ELT

Fluid	: Liquid, Solid, Powder
Wet Parts	: 316 Stainless Steel
Fork Material	: 316 Stainless Steel
Housing Material	: Aluminum, Stainless Steel (For ELT103)
Max. Solid Particle Size	: <10 mm
Max. Liquid Viscosity	: <1000 mm <sup>2</sup> / sec
Measurement Density	: For Solid > 0,1 g / cm <sup>3</sup> For Liquid > 0.7 g / cm <sup>3</sup>
Vibration Frequency	: 280 KHz (For ELT102,104, 202, 204) 300 ± 50KHz (For ELT101, 201)
Delay Time	: 0.5 sec (Vibration Stop) 1-2 sec (Vibration Start) It can be adjusted between 1-60 seconds
Exit	(For ELT101, 201) : 1 x 3A NO / NC Relay 30 VDC / 220 VAC (For ELT103) : 1 x 5A NO / NC Relay 30 VDC / 220 VAC (For ELT102,104, 202, 204) : 2 x 8A NO / NC Relay 24 VDC / 220 VAC
Supply	: 15-80 VDC, 15-260 VAC
Power consumption	: 2.5 W, 1 W (For ELT103)
Connection	: 1" BSP (Std.) Male Thread Opt. Flanged
Working Pressure	: Max. 20 bar (For ELT101, 201) Max. 40 bar (For ELT102,104, 202, 204) Max. 30 bar (For ELT103)
Working Temperature	: (-) 20 °C ... (+) 150 °C (Std.) Opt. 200 °C
Ambient Temperature	: (-) 20 °C ... (+) 80 °C
Ambient Humidity	: % 95 RH
Protection Class (EN60529)	: IP 66, IP 67 (For ELT103)

### Advantages:

- Suitable for side as well as top mounting
- Minimum and maximum fail safe field selectable.
- Process pressure max. 40 bar
- Process temperature max 200 °C
- Low power consumption.
- No Calibration Required
- Settable switching delay as a standard feature
- Durable Construction
- Immune to External Vibrations

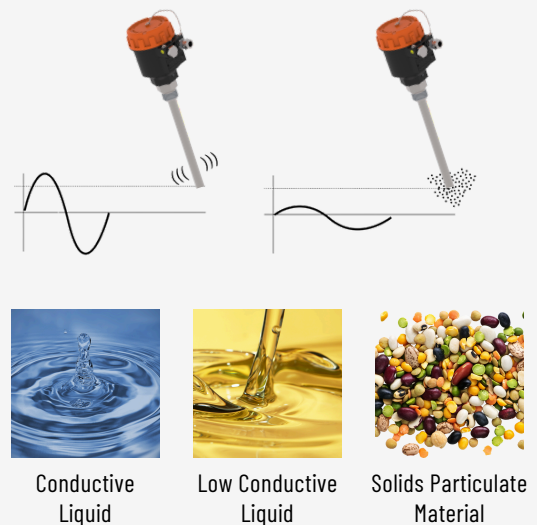

ELT series single vibrating material level switch is one of the tuning fork material level switches. It is not afraid of hanging materials, not afraid of impact, without clamping problems, and has higher sensitivity. Its cylindrical single measuring rod structure determines its wider adaptability to industrial field. Single rod vibrating level switch uses the "resonance" principle of tuning fork to generate vibration under the driving of piezoelectric elements. Only when all around the probe rod are surrounded by materials, the vibration amplitude will be sharply reduced, resulting in switch action.

### Areas of Application :

It can be used in process that containers , silos , free flowing dusts, granules and various types of small particulate solids such as cereals, beans, edible oil process, sugar, animal feed, rice plants, detergents, dye powder, chalk, gypsum, fly-ash, cement, sand, plastic granules, spices, milk powder etc.



## ELZ LEVEL SWITCH WITH DIAPHRAGM



EAC CE

### ► Technical Specifications

Installation	: Vertical
Material	: Fiber reinforced plastic. Opt. Aluminum Casting
Diaphragm	: Neoprene, Viton, Stainless Steel
Working Temperature	: (-) 20...(+) 80 ° C ELZ with NBR diaphragm 11 : (-) 20...(+) 150 ° C with Viton diaphragm ELZ 21 : (-) 20...(+) 200 ° C Rust. Diaphragm with ELZ 31
Protection Class	: IP 40 IP 53 (If the mounting position of the compensating filter is downwards) IP 65 (For ELZ31)
Max. Working Pressure	: 3 bar, NBR, for Viton Diaphragm 1 bar Stainless Diaphragm for
Weight With box	: 525 g. Plastic Body 990 g. Aluminum Body
Accuracy	: 200 g. .... 600 g. Adjustable
Electrical Connection	: PG 13,5 Plastic, PG 11 Metal (ELZ31)
Contact Output	: 1 x SPDT 15 A / 250 VAC

### ► ELZ



Level control with membrane is the most economical method in measurement of level of bulk material in the storage. It can be used in open and non-pressure tanks. ELZ can check full, empty and loaded situations of powdered, dusty, corny, granular, grained bulk materials in the grain elevator. It is appropriate for using in the particles in 0,3 and 2,5 t/m<sup>3</sup> and up to max. 30 mm. Membrane should contact with checked material certainly.

#### Advantages :

- Economical.
- Easy installation and commissioning.
- Fast delivery.

#### Areas of Application :

Sugar, Hazelnut, Clay, Sunflower Seed, Coffee, Various Granules, Wheat, Bauxite, Ceramic, Legumes, Cereal, Fish Feed, Sand, Pebble, Isolation Materials, Corn, Rice ...



Solids Particulate Material

## E-TILT TILT SENSORS

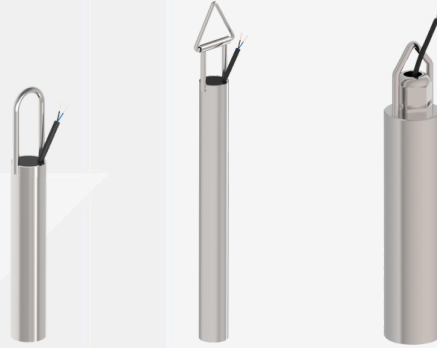

CE

### ► Technical Specifications

Tilt Angle  
(Vertically left or right)  
 $15^{\circ} \pm 3^{\circ}$  (Std.)

$25^{\circ} \pm 10^{\circ}$

$35^{\circ} \pm 10^{\circ}$

$45^{\circ} \pm 10^{\circ}$

Max. Switch capacity  
Pipe Material

Working Temperature  
Cable Length

Cable Material

Protection Class (EN60529)

### ► E-TILT

Max. Contact Current / Voltage

1,5 A / 120 VAC NC

0.6 A / 240 VAC

Opt. 1,5 A / 120 VAC

0.6 A / 240 VAC

Opt. 12,5 A / 120 VAC

7A / 240 VAC

Opt. 1 A / 120 VAC

0.4 A / 240 VAC

: 100 - 200 VA

: 304 Stainless Steel

Opt. 316 Stainless Steel, PVC

: (-)40 °C / (+)100 °C

: 2 m. (Std)

Can be added on request.

: PVC (Max. 60 °C)

Opt. Silicon, Rubber

: IP 67



E-Tilt sensor is used vertically. It can be operated by battery and also it can be operated by providing the feeding. It can be ensured to stop the water leakage by commanding the relay outlet to a solenoid valve. Furthermore, it can benefit to take measure by attracting attention of the people in the ambient by sounding the siren. Its electronic design is specially designed in order that there is no electrolysis in the lead terminal by selecting stainless steel electrode material..

### Advantages :

Easy installation, Economical, Resistant to corrosion.

### Areas of Application :

Conveyor lines, silos, ship loading telescopic arms..



Solids Particulate  
Material





## ELA FLOAT LEVEL SWITCHES

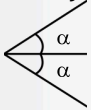

### ► Technical Specifications

Fluid	: Liquid
Appropriate Liquid Density	: Min. 0,85 g/cm <sup>3</sup> , 0,60 g/cm <sup>3</sup> .....1.4 g/cm <sup>3</sup> 0,80 g/cm <sup>3</sup> .....1.2 g/cm <sup>3</sup>
Differential Angle	: 10 ° , 25 ° , 40 ° , 65 ° , 90 ° 
Working Temperature	: Max. 60 °C , 80 °C , 120 °C
Working Pressure	: Max. 2 bar , 5 bar , 10 bar
Material of float	: PU , 304 Stainless Steel , 316 St.St. , PP
Float Dimensions	: Ø 23 , Ø 26 , Ø 65 , Ø 80 , Ø 86 , Ø 115 mm
Material of cable	: 3 x 0,3 mm <sup>2</sup> , Silicon , 3 x 1 mm <sup>2</sup> Silicon , 3 x 0,75 mm <sup>2</sup> PVC
Contact Capacity	: Max.0,1 A / 60 VAC , Max.10 A / 120 VAC Max.1,5 A / 240 VAC - 2 A / 120 VAC 5 A / 250 VAC , 6 A / 250 VAC
Contact	: 1 x NO / NC , 1 x NO , 1 x NC
Protection Class (EN60529)	: IP 68
Process Type	: Filling / Emptying , Minimum , Maximum

Cabled level switches are used in order to ensure tank, depot, waste water plant level control in the industrial facilities and dwellings. It operates without any problem in the particulate ambient with its mechanical design and there is not any jam. Neoprene rubber cable is used for resistance against different liquids and in order that it does not crack in the hot-cold ambient.

#### For example, it can be used on this fluids :

Fish ponds, swimming pools, groundwater, waste water pools, treatment pools, plunger pump applications, hydrophors, residential water tanks, etc...

#### Advantages:

Easy to install  
Reliable  
Economical

#### Application Areas :

Water, waste water, diesel, fuel oil, glycerine, gas, nitric acid 10%, acetic acid 10%, formaldehyde 40%, lactic acid 10%, hydrochloric 10%, sulphuric acid 30% etc...

## ELAr DIRTY WATER FLOAT

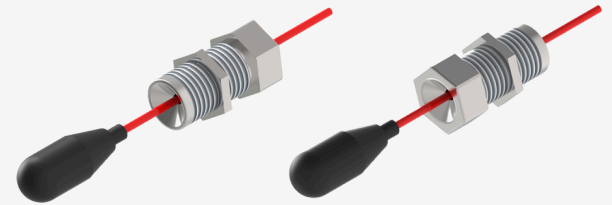

### ► Technical Specifications

Working Pressure	: Max. 2 bar
Working Temperature	: (-)40 °C...(+) 70 °C
Contact Voltage	: 60 VAC
Contact Current	: Max. 0,1 A
Contact Capacity	: Max. 0,3 A
Contact Form	: 1 x NO / NC
Mechanical Connection	: 3/4" BSP Thread Male (Std)
Nut and Connection Material	: 304 Stainless Steel (Std) Opt. 316 Stainless Steel, Delrin
Float Material	: PU
Cable Material	: Silicon Cable (Std.)
Weight	: 290 g. (With Cable 1 m.)
Min. Density	: 0,70 g/cm <sup>3</sup>
Cable Length	: 1 m. (Std) Opt. M12 Socket
Protection Class (EN60529)	: IP 65

ELR dirty water switch uses for the control of extreme dirty fluids.

It can be mounted to tank from within or outside without connection way requirement. It is perfect endurance with stainless steel record and nut.

PU material float is connected to body with silicon cable. It gives alarm information with NO or NC contact when nonmercury contact in float pass the horizontal slope angle. It is suitable for use on rail.

#### Advantages:

Not include magnetic parts.  
Stainless Steel Design  
Without mercury contact  
Independent in terms of connection

#### Application Areas :

Train carriage and dirty water store of boat, dirty water tanks, tank include particulate dirty fluid...



## ELV FLOAT VALVE

## EYG TANK LEVEL GAUGE

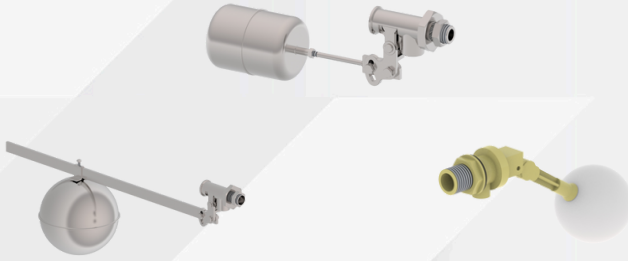

CE

### ► Technical Specifications

### ► ELV - ELVp

Body Material	: 304 St. St. , ABS Opt. 316 St. St.
Piston Bracket Material	: 304 St. St. , ABS Opt. 316 St. St.
Piston Material	: 304 St. St. , ABS Opt. 316 St. St.
Bolt + Nut + Stamp	: 304 St. St. , ABS Opt. 316 St. St.
+ Pin Material	
Seal Material	: Viton, NBR
Max.Working Temperature	: 200 °C, 60 °C
Max.Working Pressure	: 2 bar...10 bar

It is used checking liquid level in the tanks. Length of float can be adjusted with the arm, which is designed horizontally and vertically with the arm, with closed design. Valve is closed by increasing liquid level by using temperature resistance isolation material or on the contrary, valve is opened and starts to discharge with increase in the liquid level. When level decreases, valve is closed. Special connection and models can be made. Seal material can be selected in compliance with special liquids (oil, petrol, food fluids).

#### Advantages :

Special model can be produced upon demand.  
Models with shorter valve arm can be produced.  
Seal, which is resistant to oil, petrol or materials in the food sector.  
Stainless steel

#### Areas of Application :

Tank, fire-fighting water tanks, for controlling the tanks which are in without electricity environment, condensate, tanks, food storage tanks, etc.



Conductive Liquid

### ► Technical Specifications

### ► EYG

Accuracy	: ± % 5
Operating Temperature	: (-) 40 °C / (+) 85 °C
Material of Connection	: PP
Connection	: 1 1/2" BSP Male (Std)
Scale	: PVC
Stem Length	: Max. 750 mm
Material of Float	: Polyurethane
Material of Display Cover	: Transparent Polycarbonate Crystal
Material of Guide Road	: 304 Stainless Steel
Material of Shaft	: 304 Stainless Steel
Material of Ring	: NBR

EYG Tank level indicator is manufactured for displaying the level in the tank.  
Easy and quick levels can be seen by users.  
Installation can be made in a simple way.  
EYG usually used in hydraulic and fuel level measurement.

#### Advantages:

Economical  
Practical and easy mounting  
Quick delivery time  
Complete Stainless Steel.

#### Application Areas :

Machinery, hydraulic oil tanks, small warehouse etc.



Conductive Liquid



Low Conductive Liquid

## ELD LEVEL INDICATORS



### ► Technical Specifications

Body Material	: Transparent Plastic, Steel, Aluminium, Stainless Steel
Seal Material	: NBR , PTFE , Viton
Max. Working Pressure	: 2 bar , 15 bar
Max. Working Temperature	: 60 °C , 80 °C , 150 °C
Display Material	: Plastic , Glass

### ► ELD

#### Advantages:

- Liquid easily can be discharged by changing valves position
- Easy installation
- Indicator can be chosen via material types
- As optional, a contact can be mounted.
- Resist to high temperature.
- Resist to high pressure.
- Economical

#### CAPACITIVE CONTACT

The magnetic contact works according to capacitive working principle and used to receive liquid flow information without any metal parts. Accuracy can be arranged via potentiometer setting and with a led, it gives visual information to users. It can be used as a flow switch. Beside it can be used to take min. and max. contact information.



Conductive Liquid



Low Conductive Liquid

### ► Technical Specifications

Transparent Monitoring Pipe	: Acrylic Pipe or Borosilicate Glass
O-Ring	: NBR, Opt. Viton
Working Temperature	: Std. 60 °C (Acrylic) Ops. 180 °C (Glass)
Max. Working Pressure	: 2 bar , 6 bar
Connection Material and Shafts	: 304 Stainless Steel , 316 St.St. , U-PVC
Float Material (Opt.)	: 304 Stainless Steel

### ► ELD

It is an economic level monitoring indicator, which is designed for monitoring flow in the pipe lines for machine manufacturers, food factories. It can be installed horizontally or vertically.

#### Areas of Application :

Hydraulic tanks, pressure vessels, cooling tanks, hydraulic lines and oil vessels.

Transparent Monitoring Pipe	: Max.10 mm. (ELD-A)
O-Ring	: Ø 8 - 12 mm (thickness max. 1 mm.) (ELD-B)
Working Temperature	: mm.) (ELD-B)
Tank Surface	: Ø1 2 - 26 mm (thickness maks.1.5 mm.) (ELD-C)
Suitable Mounting Type	: ABS Plastic (Heat resistant)
Pipe	: 32 x 19 x10 mm
Body Material	: IP 66
Protection Class (EN60529)	: 70 g.
Weight	: 2 m.
Cable Length	: 60 °C
Working Temperature	: 12...24 VDC
Supply	: 300 mA max.
Load	: Black
Color	: LED
Display	: 0,5 sec.
Time to Answer	: NPN - NO
Output	

## EFS FLOW SWITCHES



### ► Technical Specifications

Material	Body+Thread+Nut	: AISI 304 St.St. (Opt. AISI 316 St.St.)
	Relay Case	: AISI 304 St.St. (Opt. AISI 316 St.St.) , Ops. Hastelloy
	Bolt	: AISI 316 Stainless Steel , Ops. Hastelloy
	Palette	: AISI 316 Stainless Steel , Ops. Hastelloy
	T Body	: Polypropylene
	Magnet Case	: Polypropylene
	O-Ring	: FPM
Fluid		: Water (Oil, gas and aggressive media on request)
Tolerance		: ± % 15 of full scale value
Max. Working Pressure		: 25 bar
Working Temperature		: (-) 20 °C / (+)110 °C
Ambient Temperature		: (-) 20 °C / (+)70 °C
Contact		: Reed Switch SPST - NO
Contact Current		: 1 A
Max. Contact Power		: 10 W / VA
Max. Switching Voltage		: 200 VDC / 140 VAC
Electrical Connection		: ISO 4400 Socket Opt.Cable Output, Socket with LED
Protection Clas		: IP 65, IP 67 (for sx, cx type) , IP 66, IP 68

### ► EFS ..s / DX-EFS ..s (Stainless Type)

### ► EFS ..p (Plastic Type)

		: Polypropylene
		: Polypropylene
		: Polypropylene
		: Polypropylene
		: Polypropylene
		: Polypropylene
		: Polypropylene
		: NBR
		: Water (Oil, gas and aggressive media on request)
		: ± % 15 of full scale value
		: 10 bar
		: (-) 20 °C / (+)70 °C
		: (-) 20 °C / (+)70 °C
		: Reed Switch SPST - NO
		: 1 A
		: 10 W / VA
		: 200 VDC / 140 VAC
		: ISO 4400 Socket Opt.Cable Output, Socket with LED
		: IP 65, IP 67 (for px, bx type)

EFS is used in order to check safely whether there is flow or not by detecting movement of liquids inside the pipe. It provides information about flow with high reliability without spending energy in cooling water or lubricating oil circuits, in the devices such as flash heater, central heating boiler and heater. It should be assembled vertically. As factory setting, contact is closed when there is flow; contact is open when flow stops. Exact opposite situation can be adjusted by user by changing position of relay in the housing.

#### Working Principle :

Palette, fastened from one point on the body, moves contact with fluid so that information about flow is obtained. When flow stops, it is provided that paddle comes to first position by pushing magnet with reverse pole in the paddle, attached on the body. By this means, longer life and resistance to higher pressure is provided in comparison with those of spring mechanisms. Reed relay with high precision and long life is used.

#### Advantages :

High precision , Easy to adjust and assemble , Relay circuit is contactless with fluid. Low pressure decrease. Economical

#### Application Areas :

Irrigation systems, low viscosity oil and acids, hot oil lines, heating and cooling systems, water installations.



Conductive Liquid



Low Conductive Liquid



## EFS FLOW SWITCHES



### ► Technical Specifications

### ► EFS

Fluid	: Liquid , Air , Hot Oil
Working Temperature	: (-)20 °C / (+) 90 °C , (-) 20 °C / (+) 85 °C (-)40 °C / (+) 300 °C
Working Pressure	: Max. 10 bar , Max. 5 bar , Max. 20 bar
Paddle Material	: 316 Stainless Steel
Switch Bracket	: Coated Steel , 304 Stainless Steel
Connection Material	: Brass (MS 56) , Chrome Plated Steel , St.St.
Paddle Rod Material	: Brass (MS 56) , Stainless Steel
Housing Material	: PP , Aluminium , Stainless Steel
Bellow Material	: Bronze , Stainless Steel
Seal Material	: NBR , PTFE
Contact	: 1" NPT Male Thread , Hole Flange
Pipe Diameter	: from 1" to 8" - DN 25 to DN 200 (For Liquid) Channels greater than 300 cm <sup>2</sup> (For Air)
Connection	: 15 A 250 VAC , NO/NC
Protection Class (EN60529)	: IP 65

#### Advantages :

- Suitable for hot and cold liquids
- Air tight design
- Can be used in hot oil
- Economical

EFS Flow Switches are used for the monitoring of liquid flow in pipes. When the liquid flow stops or starts its paddle actuates a microswitch (NO/NC) , hereby electrical equipments are protected .The flow switch is suitable to use all kinds of non-corrosive liquid. Flow adjustable via screw mechanism.The products are factory setted. Users can change the adjustment according to application needs.

#### Applications :

Irrigation systems, low viscosity oil and acids, hot oil lines, heating and cooling systems, water installations.



Conductive Liquid



Low Conductive Liquid

### ► Technical Specifications

### ► EFS

Working Pressure	: 31 bar (450 PSI)
Test Pressure	: 62 bar (900 PSI) %100
Working Temperature	: 4.5 °C - 50 °C (40 °F - 120 °F)
Contact	: 2 x 10 A 125 / 250 VAC 2.5 A 6 / 12 / 24 VDC

#### Nominal Pipe Size

Inch	mm	Inch	mm
2	DN 50	1,25 + 0,125 / - 0,62	33,0 ± 2,0
2 1/2	DN 65		
3	DN 80	2,00 ± 0,0125	50,8 ± 2,0
4	DN 100		
5	DN 125		
6	DN 150		
8	DN 200		

#### Advantages :

- Double contact output.
- Can be connected with U-Bolt.
- Suitable for fire lines.

## EFS FLOW SWITCH

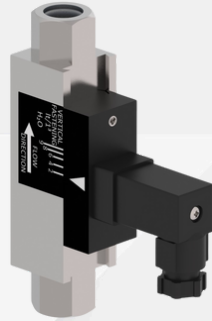

### ► Technical Specifications

Fluid	: Water, Air
Connection Size	: 1/4" BSP, 1/2" BSP , 1" BSP (Std.)
Body Material	: Brass (Nickel Plated) (Std.) Opt. Stainless Steel
Seal Material	: EPDM (Std.) Opt. Viton
Spring Material	: 304 Stainless Steel
Thread Material	: Brass (Std.) Opt. Stainless Steel
Contact Material	: Plastic
Magnet Material	: Alnico
Working Temperature	: 100 °C Opt. 120 °C (Stainless Steel)
Accuracy	: ± % 5 Full Scale
Contact	: 1 x NO 1A / 200 VAC
Max. Working Pressure	: 300 bar
Protection Class	: IP 65

### ► EFS

#### Advantages :

- Can be used in hot and cold water / air.
- Fully waterproof - air light design.
- Economical.
- High static pressure.

EFS 71 Flow Switch works with the power of the current in order to monitor the flow with high reliability. Mechanism works with the triggering of the reed switch inside by float while moving in the direction of flow. The reed switch is adjustable from outside of the body. Hysteresis (delay) is the difference in flow between the switch closing and opening again. The difference is the result of the movement required by the float to reclose the open contact. Therefore, shorter the difference; greater the accuracy. Choosing of the right magnets and reed switches; the delay of EFS 71 is adjusted to minimum.

#### Applications :

Monitoring of cooling circuits in welding machines, compressors, heat exchangers and centrifuges. Monitoring of sealing media for seals and pump dry running, motor cooling systems etc.

## EFS HERMAL FLOW SWITCH



### ► Technical Specifications

Measurement Range	: Water : 0,3...3 m/sec Air : 2...3 m/sec Oil : 0,3...3 m/sec
Accuracy	: ± %1 , ± 0,1 m/s
Setting Time	: 3 min.
Max. Pressure	: 100 bar
Ambient temperature	: (-) 20 °C ... (+) 80 °C
Material of Housing	: PVC
Material of Wetted Parts	: 316 Stainless Steel
Setting	: With potentiometer
Output	: PNP - NO / NC Relay - NO / NC Opt. NPN-NO/NC
Contact Current	: 5A / 250 VAC 30 VDC For Relay Max. 250 mA For PNP or NPN
Power Supply	: 24 VDC (Std.) Opt. 220 VAC
Consumption Current	: <60 mA
Response Time	: 2 (2...10)sec
Max. Temperature Change	: 300 K/min.
Gradient of Medium	
Output Protection	: Reverse, Short, Overload
Electrical connection	: M12 Socket
Protection Class	: IP 67

### ► EFS

#### Advantages :

- No electricity
- Corrosion resistant stainless steel construction
- Small, lightweight
- Maintenance free
- Cooling temperature can be adjusted
- Long life
- Quiet operation

It is a cooling apparatus that provides great savings in the long term for cooling the cutting and drilling tools used in the industry. It ensures effective operation of the part in which it is used and also provides profit for the company by using exhausted air carelessly in general. It can produce cold air up to approximately 35 °C or 40 °C.

#### Applications :

It is used for cooling operating parts of product equipments such as guide, saw, milling cutter, tool bit, and for preparing melt in the cameras, laser cutting machines.

## EFS FLOW SWITCHES

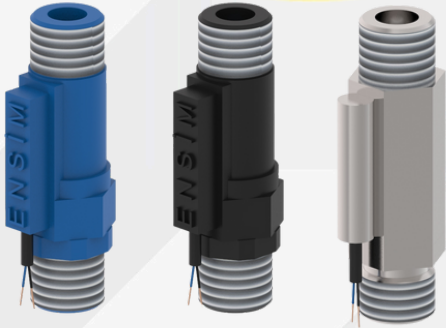

### ► Technical Specifications

Fluid	: Liquid
Working Temperature	: 0 / (+) 60 °C , (-)20 °C / (+)100 °C
Working Pressure	: (-)30 °C / (+)125 °C
Output	: Max. 10 bar , Max. 20 bar
Connection	: NO Single Contact (Reed Relay)
Cable	: 1/2" BSP Male Thread
Spring and Rove Material	: 0.5 m. PVC
Body Material	: Stainless Steel
Body Colour	: PP , PVC , Stainless Steel
Accuracy	: Blue , Gray
Contact	: Adjustable
	: 0.7 A 10 W 150 VDC / 120 VAC

### Advantages :

- Economical.
- Relay circuit contactless with fluid.
- Easy to install.

EFS is used in oraler to check safely whether there is flow or not by detecting movement for liquids inside the pipe. It provides information about flow with high reliabilty with out spending energy in cooling water, in the devices such as flash heater, central heater boiler and heater. It should be assembled vertically.

### Applications :

Hot / cold water , steam, compressed air, fuel oil, pharmaceutical and food industry and other fluid lines, food machinery and process lines ...



Conductive Liquid



Low Conductive Liquid

## EFD FLOW DISPLAY

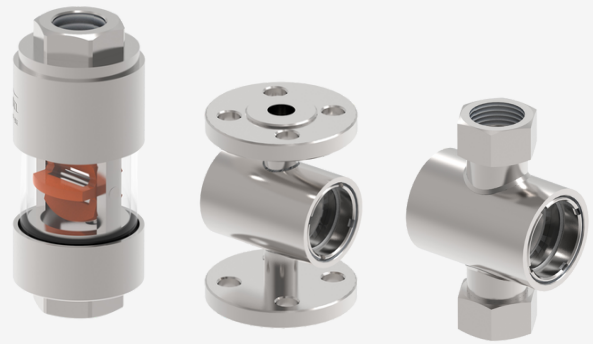

### ► Technical Specifications

Body Material	: 304 Stainless Steel
	Opt. 316 Stainless Steel
Monitoring Material	: Tempered Glass
	Double Glass
Seal Material	: Klingrid (std)
	Opt. PTFE or Spiral wound
Pipe Diameter	: DN 15....DN 50 Flange
	1/2" BSP... 2" BSP Thread
Max. Working Temperature	: 200 °C
	Opt. 300°C
Max. Working Pressure	: 16 bar
	Opt. 40 bar

### Advantages :

- Complete stainless steel.
- Suitable for food.
- Easy to install.

EFD is used for monitoring flow in process lines. Must be careful to choose a model which is compatible with liquid characteristics in line. It is available for monitoring from both of side. As optional, flow switch can be assembled in the body. To warrant its vigorously working should be used a filter in the line. Can be manufacturing according to customers need For different pressure range and different mounting types, etc.



## ENABAR PITOT TUBE

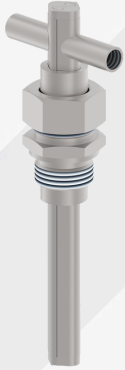

### ► Technical Specifications

Fluid	: Liquid, Steam, Gas
Working Temperature	: (-)270 ... (+) 600 °C
Working Pressure	: Max. 100 bar
Body Material	: 316 Stainless Steel
Accuracy	: < %100 Measured Value
Internal Diameter	: DN 50 ... DN 1000

### ► ENABAR

#### Advantages :

- Economical
- Long service intervals
- Shorter inflow and outflows sections
- Easy to install
- Integrated pressure and temperature transmitter

Enabar series pitot tube measures flow in pipes based on the difference pressure principle.

It is a sensitive measuring instrument that can work under difficult conditions.

#### Applications :

Hot / cold water , steam, compressed air, fuel, water..



Conductive  
Liquid



Low Conductive  
Liquid

## ENVORTEX VORTEX COOLER

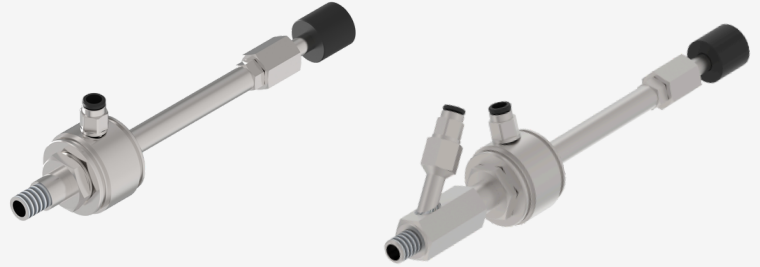

### ► Technical Specifications

Max. Working Pressure	: 7 Bar
Flow Range	: 6 m <sup>3</sup> /hour
Weight	: 500 g.

### ► ENVORTEX VT1

#### Advantages :

- No electricity
- Corrosion resistant stainless steel construction
- Small, lightweight
- Maintenance free
- Cooling temperature can be adjusted
- Long life
- Quiet operation

It is a cooling apparatus that provides great savings in the long term for cooling the cutting and drilling tools used in the industry. It ensures effective operation of the part in which it is used and also provides profit for the company by using exhausted air carelessly in general. It can produce cold air up to approximately 35 °C or 40 °C.

#### Applications :

It is used for cooling operating parts of product equipments such as guide, saw, milling cutter, tool bit, and for preparing melt in the cameras, laser cutting machines.

# EFO FLOW MEASUREMENT WITH ORIFICE

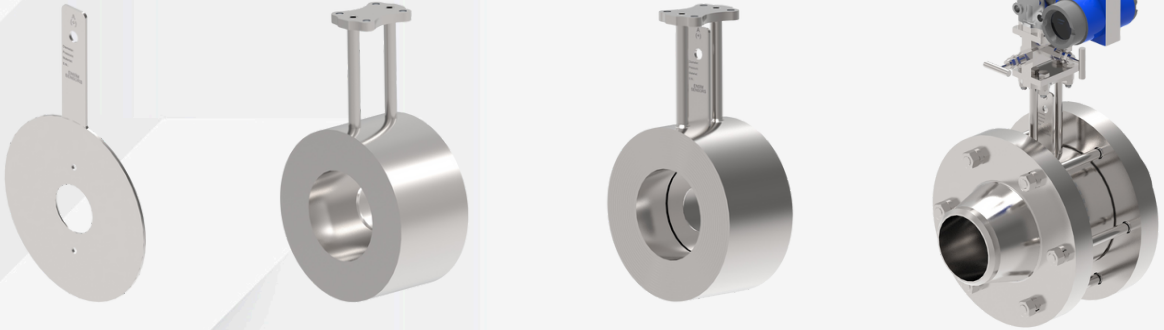

## ► Technical Specifications

## ► EFO

Type	: Orifice Plate Compact Orifice Plate- With Flange Compact Orifice Plate - D -D/2 Type Single (monolith) Block Orifice Compact (monolith) Block Orifice Double Block Orifice Compact Double Block Orifice
Plate Material	: 304 Stainless Steel , 316 Stainless Steel
Body Material	: 304 Stainless Steel , 316 Stainless Steel
Gasket Material	: PTFE (Std.)
Bolt, Nut Material	: Carbon Steel , 304 Stainless Steel , 316 St.St.
Flange Material	: Carbon Steel , 304 Stainless Steel , 316 St.St.
Flange standard	: EN 1092-1 , ANSI B16.5
Pipe Dimension	: DN 50.... DN 400 mm
Pressure Class	: PN 10 / 16 / 25 / 40 / 64 , 150 lbs / 300 lbs / 600 lbs
Temperature	: (-)100 °C...(+) 500 °C
Fluid	: Fluid, Steam, Gas
Marking	: Flow up (+) face

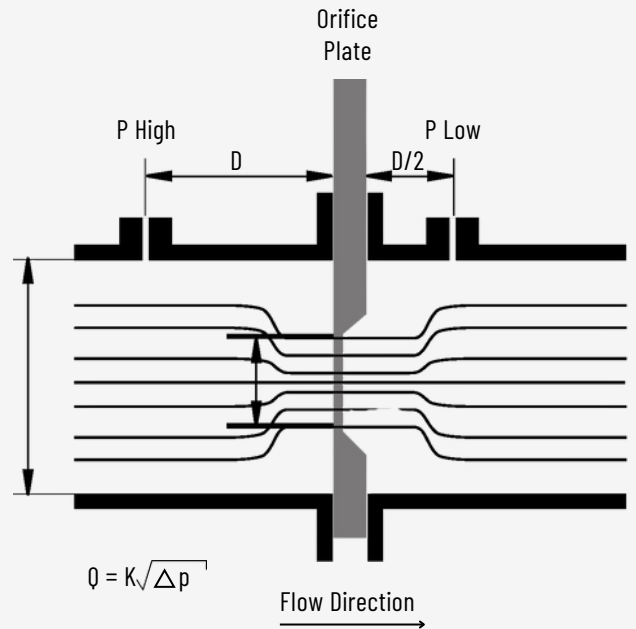

$\Delta P = P \text{ High} - P \text{ Low}$   
 $Q$  : Flow  
 $K$  : Correction Factor

### Advantages :

- Can be used in liquids and gases
- No moving parts
- Low risk of malfunction
- Low Cost

In industrial facilities, different types of flow measurement devices are being used, and each measuring method have advantages to each other, which depends on where they are being used. EFO model orifice plates are the most frequent method for flow measurement.

It works according to Bernoulli theorem.

Volume value of a flow inside a constant space in a pipe, equals to square root of differential pressure value created by orifice plate inside that pipe. It is mounted on where flow is laminar.

A flat stainless-steel metal plate is drilled as calculated holes therefore the pressure difference between inflow and outflow can be calculated.

Options are available for measure of the holes and type of the flow.

Accuracy of measurement is affected by production measures and quality, mounting conditions and type of the liquid.

Model EFO offers economic and easy mounting solution for variety of liquid types. Model EFO produced in EN ISO 5167 standards.

# EFM ELECTRO MAGNETIC FLOWMETER



## ► Technical Specifications

Measure Group	: Liquids
Pipe Diameter	: DN 10 ... DN 2400 mm
Speed Measure Interval	: 0.1 m/sec to 10 m/sec
Flow Measure Interval	: 0.0045 m <sup>3</sup> to 113 094 m <sup>3</sup>
Case Material	: Aluminum Alloy, Opt. 304 Stainless Steel , 316 Stainless Steel
Sensor Material	: 316 SS. , Opt. Hastelloy C, Opt. Hastelloy B, Titanium, Tantalum
Wet Part Material	: PTFE or Rubber
Temperature Interval	: (-) 20 °C / (+)150 °C PTFE ; (-) 20 °C / (+) 60 °C Rubber
Sensitivity	: 0.2 % High Sensitivity
Humidity Interval	: 5 - 95 % RH
Minimum Conductivity	: 20 µS
Connection	: Flange Connection
Supply	: 85...265 VAC or 24 VDC
Protection Class	: IP 67 Opt. IP 68
Output	: Pulse, Analog, RS 485, Relay
Sample Interval	: 0.2 secs to 100 secs Daily
Record	: Weekly, Monthly, Annually Total

## ► EFM

Electro-magnetic flowmeters are commonly preferred in flow measure of conductive liquids. Electro-magnetic flowmeters returns volumetric values as L/sec. , L/min. , L/h. , m<sup>3</sup>/sec., m<sup>3</sup>/min., m<sup>3</sup>/h. Electromagnetic method is based on Faraday's Law of Induction. Due to following aspects, electromagnetic flowmeters are advantages: Not-including moving part, wet part's material are optional for different liquids, no pressure loss, showing excellent performance. Electromagnetic flowmeters outputs current flow and total flow thus; with the help of electrical signals returns data of flow to the system.

### Applications :

Treatment Plants, Chemical, Petrochemical Industry, Food Sector, Textile Industry, Paper Production Sector, Power Plants, Water Distribution Networks Agricultural irrigation sector.

## ► Technical Specifications

Input (Selectable)	: 4-20 mA, 0-10 VDC, 0-5 VDC, Puls (PNP,NPN,Push-Pull,Reed)
Output (Selectable)	: 4-20 mA , 0-10VDC ve Puls (push-pull )
Communication	: Modbus RTU-RS485
Analog Input Resolution	: 10 bit
Digital Input Speed	: Max.10 KHz
Digital Output Speed	: Max. 50 Hz
Indicator	: 4.3" 480 mm x 272 mm pixel resistive touchscreen
Working Humidity	: % 10...% 85 (Non-condensate)
Power Supply	: 24 VDC, ±%10
Power consumption	: 3 W
Dimensions	: 144 mm x 144 mm (Front) , 134 mm x 134 mm (Rear) , Depth 100 mm
Protection Class	: IP 65 (Front)

## ► SMART CONTROL DEVICE

### Advantages :

Tft Display  
The Units Can Be Selected On The Display.  
Simulation Properties

ESD100 Series, is the universal input is suitable for many measuring sensors. (Panel type pressure,temperature, level and flow display)Thanks to TFT display it can be easily read in dark or sunny environments. The selected units can be seen on the display. Device has standard communication output which can be also simulated.



Conductive Liquid





# EF FLOWMETER

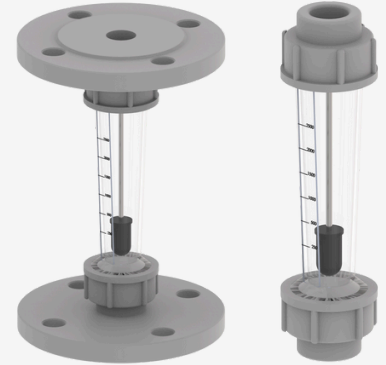
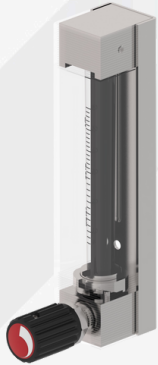

### ► Tech. Specifications

### ► EF

Measuring tube	: Borosilicate Glass
Tube Length	: 100 mm
Protection Class	: Polycarbonate
Float Stop Material	: PTFE
Float Material	: 316 Stainless Steel
Seal Material	: Viton
Max. Working Pressure	: 16 Bar
Max. Working Temperature	: 100 °C
Connections (R)	: 1/4" BSP / NPT
Needle Valve	: 316 Stainless Steel
Accuracy	: Class 2.5
Weight	: 600 g.

It is designed to be adjustable precisely for small flow. It is an economical flowmeter as well as it enables comfortable following and adjusting outflow with its compact structure.

#### Advantages :

- Wetted parts are stainless steel
- With needle valve
- Accurate flow setting

#### Areas of Application :

Water, air, various gases.



Conductive Liquid



Low Conductive Liquid

### ► Tech. Specifications

### ► EF

Fluid	: Water, Air
	Special fluids should be stated
Max. Working Pressure	: 7...15 bar
Max. Working Temperature	: 150 °C
Measuring Tube	: Borosilicate Glass
Float Material	: 316 Stainless steel
Float Stop Material	: PTFE
Connections	: 316 Stainless steel
Case	: Coated Steel
Accuracy	: +/- %1 t.s.

Float which moves freely without friction in the measuring tube, changes location by being pushed by fluid. This changing flow rate depends on weight of float an density and viscosity of fluid. Pressure olecase remains area by rasing flow rates so asto depend on increasing flow area by rasing flow rate and speed of fluid. It should be assembled vertically.

#### Advantages :

- Wetted parts are stainless steel
- Accurate flow setting

### ► Tech. Specifications

### ► EF

Fluid	: Water or Air
Max. Working Pressure	: 10 bar
Max. working Temperature	: 70 °C
Measuring Tube	: Trogamid
Float Material	: PVDF
Guide Material	: 316 Stainless Steel
O-Ring Material	: Viton
Connections	: Thread
Accuracy	: ± % 3 t.s.

Float which moves freely without friction in the measuring tube, changes location by being pushed by fluid. This changing flow rate depends on weight of float an density and viscosity of fluid. Pressure olecase remains area by rasing flow rates so asto depend on increasing flow area by rasing flow rate and speed of fluid. It should be assembled vertically.

#### Advantages :

- Easy monitoring
- Contact can be mounted

# EF TURBINE FLOWMETER

## EF MINI TURBINE FLOWMETER



► Technical Specifications

► EF 24

Fluid	: Liquid
Working Temp.	: -10/+85 C
Max. Pressure	: 10 bar
Range	: 2...40 l/min
Output	: 1070 Puls/l ( NPN)
Accuracy	: +/- %1
Connections	: 3/4" BSP Male
Cable	: PVC 2 m.
Wetted Parts	: ABS
Protection	: IP 68
Power Supply	: 4,5 ... 24 VDC

► EF 34 / 54

Fluid	: Liquid
Working Temp.	: -10/+85 C
Max. Pressure	: 10 bar
Range	: 3...150 l/min 7...400 l/min
Output	: 1070 Puls/l ( NPN)
Accuracy	: +/- %2 , %3
Connections	: 1 1/4" BSP Male, 2" BSP Male
Cable	: PVC 2 m.
Wetted Parts	: ABS
Protection	: IP 68
Power Supply	: 4,5 ... 24 VDC

► EF 100

Fluid	: Liquid
Working Temp.	: 0/+80 C
Max. Pressure	: 10 bar
Range	: 0,15...8m/sec.
Output	: Puls (NPN)
Accuracy	: +/- %2
Connections	: 1 1/4" BSP Male (DN 15 ...100)
Cable	: PVC 0.2 m.
Wetted Parts	: ABS
Protection	: IP 68
Power Supply	: 4,5 ... 24 VDC

It's designed for low flow measuring and monitoring. With the compact form it ensures high accurate flow measurement and control. Cable and high precision pulse sensor placed into the body provides to get accurate values in the long time.

**Areas of Application :**

Smart drinking Fountains , beverage industry , tes and coffee machine , water purifier , liquid filling machines...

**Advantages :**

Economical.  
Easy to assemble.  
Easy to adjust.



Conductive Liquid

► Technical Specifications

► EF 06

Fluid	: Liquid
Working Temp.	: -25/+120 C
Max. Pressure	: 10 bar
Range	: 0,05...15 l/min (5 Flow Ranges)
Accuracy	: +/- %1
Connections	: Ø6mm. Hose
Output	: (NPN / PNP) Pulse/l

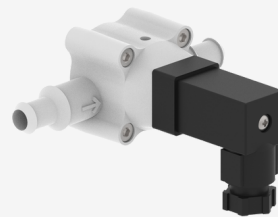

**Areas of Application :**

Beverage industry, dosing app. ...

**Advantages :**

Economical.  
High Accuracy.



## EPS PRESSURE / DIFFERENTIAL PRESSURE SWITCH

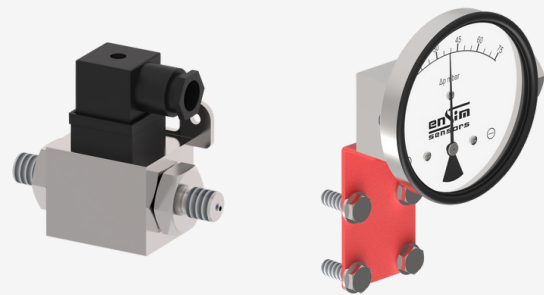
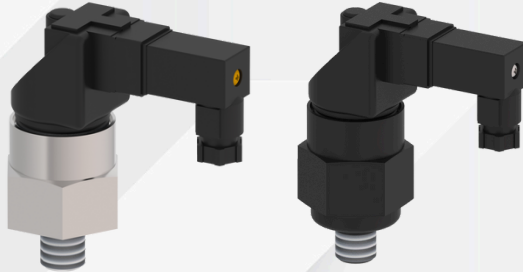

### ► Technical Specifications

Body materials	: 316 St.St., PP
Range	: 0...(+) 1 bar / 3.5 bar / 5 bar / 10 bar 20 bar / 100 bar / 200 bar / 400 bar (-) 0.8 bar ... (-) 01 bar
Diaphragm	: NBR, Stainless Steel, Viton
Plastic Parts	: PP
O-Ring	: NBR
Mechanical Connections	: 1/4" BSP. , 1/2" BSP
Max. Pressure	: x 1.5
Max. Current	: 5 A / 250 VAC
Contact	: 1 x NO / NC
Working Life	: 10.000.000 times (Depends on working range)
Working Temperature	: (-) 40 °C...(+) 150 °C , (-) 25 °C...(+) 60 °C
Relative Humidity	: 5-95 % RH
Protection Class (EN60529)	: IP 65

### ► EPS

#### Advantages :

High reliable accuracy  
Easy adjustable  
Economical

Inside the body , there are a compressed spring and a diaphragm. The spring and diaphragm move with pressure and trigger the contact and give pressure information. When the pressure is come down to adjusted pressure value , the contact is turn back to former position. High precision and durable contact is used.

The EPS Pressure Switch is used for inline pressure measurement and control. The ideal type of assembly is vertical.

#### Application Areas :

It provides pressure information at high reliability without consuming energy in cooling water or lubricating oil circuits in devices such as water heater, combi boiler, heater. Filters, level measurement, backflow systems.

### ► Technical Specifications

Model	: EPS200
Diff. Pressure Range	: 0,3 bar... 3 bar
Display	: Not available
Repeatability	: ± % 2 , at 20 °C
Average Dead Band	: 0.25 bar until 1.5 bar 0.8 bar until 1.5 bar
Max. Pressure	: 35 bar
Contact	: 1 x NO/NC , 3 A / 250 VAC
Electrical Connection	: DIN 43650 A Socket
Mechanical Connection	: 1/4 " BSP Std
Working Temperature	: (-) 20 °C...(+) 80 °C Ops.(-) 40 °C...(+)120 °C
Body Material	: Aluminium
Diaphragm Material	: Buna-N, Opt. Viton
Connection	: Steel Opt. Stainless Steel
Spring	: Stainless Steel
Protection Class (EN60529)	: IP 65
Weight	: 0,5 kg

### ► EPS 200

### ► EPS 500

Model	: EPS500
Diff. Pressure Range	: 0,5 bar ... 4 bar
Display	: Available
Repeatability	: ± % 2 , at 20 °C
Average Dead Band	: 0.25 bar until 1.5 bar 0.8 bar until 1.5 bar
Max. Pressure	: 10 bar
Contact	: 1 x NO/NC , 3 A / 250 VAC
Electrical Connection	: DIN 43650 A Socket
Mechanical Connection	: 8 mm Hose
Working Temperature	: (-) 20 °C...(+) 80 °C Ops.(-) 40 °C...(+)120 °C
Body Material	: Stainless Steel
Diaphragm Material	: Buna-N, Opt. Viton
Connection	: Stainless Steel
Spring	: Stainless Steel
Protection Class (EN60529)	: IP 65
Weight	: 1,25 kg



## EPS OEM PRESSURE SWITCH



### ► Technical Specifications

Type  
Working Principle  
Size range

Static Pressure  
Working Temperature  
Mechanical Connection  
Connection Material  
Output  
Contact Sensitivity  
Contact Life  
Protection Class (EN60529)

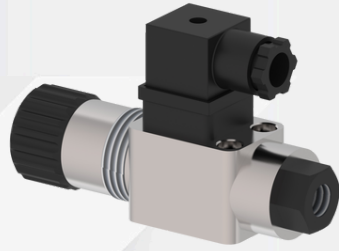

### ► EPS...h

: Hydraulic  
: With Piston , Adjustable  
: 50 - 350 bar

: Max. 500 bar  
: (-)20 °C... (+) 100 °C  
: 1/4" BSP Female (Std.)  
: Aluminum Casting  
: 2 A NO / NC - 42 / 220 VAC  
: < % 3  
: 500000 times  
: IP 65



### ► EPS...c

: High Pressure  
: With Piston , Stationary  
: 50 - 150 bar  
50 - 200 bar

: Max. 500 bar  
: (-)20 °C... (+) 100 °C  
: 1/4" BSP , 1/8" BSP (Std.)  
: Steel-Nickel Coated Opt. Brass. St.St.  
: 2 A NO / NC - 42 / 220 VAC  
: < % 5  
: 1000000 times  
: IP 65



### ► EPS...c

: Low Pressure  
: With Membrane , Stationary  
: 1 - 5 bar  
1 - 10 bar  
10 - 20 bar  
20 - 50 bar

: Max. 300 bar  
: (-)20 °C... (+) 100 °C  
: 1/4" BSP , 1/8" BSP (Std.)  
: Steel-Nickel Coated Opt. Brass. St.St.  
: 2 A NO / NC - 42 / 220 VAC  
: < % 5  
: 1000000 times  
: IP 65

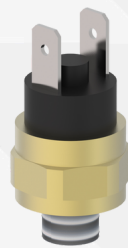

### ► Technical Specifications

Type  
Working Principle  
Size range

Static Pressure  
Working Temperature  
Mechanical Connection  
Connection Material  
Output  
Contact Sensitivity  
Contact Life  
Protection Class (EN60529)

### ► EPS...v

: Vacuum  
: With Membrane , Stationary  
: (-)200 mbar ... (-)800 mbar

: Max. 20 bar  
: (-)20 °C... (+) 100 °C  
: 1/4" (Std.) BSP  
: Steel-Nickel Coated Opt. Brass. St.St.  
: 2 A NO or NC - 42 / 220 VAC  
: < % 5  
: 1000000 times  
: IP 65



### ► EPS...m

: Mini  
: With Membrane , Stationary  
: 0,1 - 1 bar , 0,5 - 5 bar  
1 - 10 bar , 10 - 20 bar  
20 - 50 bar                      50 - 100 bar

: Max. 300 bar                      Max. 500 bar  
: (-)20 °C... (+) 100 °C  
: 1/4" BSP , 1/8" BSP (Std.)  
: Steel-Nickel Coated Opt. Brass. St.St.  
: 2 A NO or NC - 42 / 220 VAC  
: < % 5  
: 1000000 times  
: IP 65

### Advantages :

Small size.  
Long life.  
Easily adjustable and mounted  
Economical

## EPS PRESSURE SWITCH

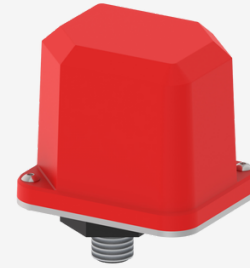
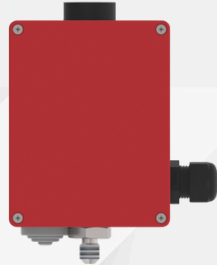

### ► Technical Specifications

### ► EPS

Contact Pressure	: 3 bar (when it falls) It can be manufactured upon request
Max. Working pressure	: 200 bar
Test Pressure	: 300 bar
Contact	: 2 x 10A NO / NC - 250VAC
Housing Protection Class	: IP 54
Red Color Protection Button	: (Above)
Test Button	: (Below)
Connection	: 1/4" BSP (Std.) Ops. Can be manufactured upon request
Housing Material	: Aluminium
Working Temperature	: (-) 20 / (+) 50 ° C
Process Connection Material	: 304 Stainless Steel (Std.)
Electrical Connection Material	: PG 11 Plastic

EPS 300 Model pressure switch is designed for wet or dry pipe systems with alarm check-valves preaction or deluge valves; in such special designs with automatic fire sprinkler systems to be used for detecting water flow. It is also used in low pressure control, between 3-15 PSI (0 - 10bar) adjustable.

#### Advantages :

Test button is available.  
There is an arming button.  
Max. working pressure.  
It is easy to commission.

#### Applications :

Fire pipelinecontrol systems, liquid pipelines that needs pressure regulation.



Conductive Liquid



Low Conductive Liquid

### ► Technical Specifications

### ► EPS 1000

Thread Material	: Polyamide Fiber
Housing Material	: Polyamide Fiber
Diaphragm Material	: Viton
Contact	: 10A-125 / 250 VAC 2,5A-24VDC
Output	: 1 or 2 Relay NO/NC
Connection	: 1/2" BSP Male Thread (Std.)
Dimensions	: 85x102x123 mm
Measure Area	: 0-10 bar (std.) Opt.
Working Temperature	: (-)0...(+)60 °C
Default Setting	: 0,2 - 1,0 bar (3-15 PSI)
Max. Working pressure	: 21 bar (300 PSI)
Differential	: 0,21 bar 3 PSI
Protection Class	: IP 66
Weight	: 290 g.

EPS 400 Model pressure switch is designed for wet or dry pipe systems with alarm check-valves preaction or deluge valves; in such special designs with automatic fire sprinkler systems to be used for detecting water flow. It is also used in low pressure control, between 3-15 PSI (0,2-1 bar) adjustable.

#### Advantages :

Economical.  
Set value can be adjusted..

#### Applications :

Fire pipelinecontrol systems, liquid pipelines that needs pressure regulation.



## ELX COOLING APPARATUS



### ► Technical Specifications

Material	: ST 37 Steel, 304 Stainless Steel 316 Stainless Steel
Max. Working Pressure	: 16 bar , 30 bar
Working Temperature	: 250 °C
Total Length	: 180 mm , 240 mm , 290 mm
Process Connection	: 1/4" BSP, 1/2" BSP Female ,1/2" BSP Male
Sensor Connection	: 1/4" BSP, 1/2" BSP Female , 1/2" BSP Male



### ► SIPHON

### ► THERMOWELL

: 304 Stainless Steel Opt. 316 Stainless Steel
: 16 bar (Std.) Opt. 30 bar
: 250 °C (Std.) 600 °C
: According to the order
: It is selected from the table
: It is selected from the table



### ► Technical Specifications

Material	: 304 Stainless Steel Opt. 316 St.St.
Max. Working Pressure	: 30 bar
Working Temperature	: 1200 °C / 800 °C / 400 °C
Total Length	: 200 mm / 150 mm / 100 mm
Process Connection	: 1/4" BSP, 1/2" BSP Female
Sensor Connection	: 1/4" BSP, 1/2" BSP Female



### ► CAPILLARY COOLER

### ► COOLER

: 316 Stainless Steel
: 80 bar
: 180 °C / 250 °C
: 87 mm /107 mm
: 1/2" BSP
: 1/2" BSP , 1/4" BSP



### ► Technical Specifications

Max. Working Pressure	: 25 bar Opt. 50 bar
Max. Working Temperature	: 238 °C
Body	: 304 Stainless Steel Opt. 316 St.St.
Serpentine Cooler Liquid	: Copper Pipe Opt. 316 Stainless Steel
Input-output connection	: 1/4" BSP
Max. Body Pressure	: 10 bar Opt. 50 bar
Elbow Material	: 304 Stainless Steel Opt. 316 Stainless Steel
Volume	: 2 L.



### ► SAMPING VESSEL

### ► CONDENSATION TANK

Material	: 316 Stainless Steel
Test Pressure	: 155 bar
Connection	: 3 x 1/2" BSP



### ► Technical Specifications

Material Thickness	: 0,15 ... 2 mm
Diameter	: 6 ... 80 mm
Length	: Up to 900 mm
Material	: 316 St. St. , Bronze

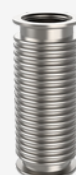

### ► ENBELLOW



Conductive  
Liquid



Low Conductive  
Liquid



## ELX INSTRUMENT VALVE

Needle valves are designed especially for corrosive and dangerous environments. These valves can be used in the process control, instrumentation and flow control application. It is designed with maximum efficiency in order to provide high quality and low cost in various liquid and gas control system.

Test pressure : x 1,5

**Standard;**

Design: ASME B16.34

Wall Thickness: ASME B16.34

Pipe Thread: ASME B1.20.1.B521

DIN 2999 / 259 , ISO228/1 , JIS.B 0203 , ISO7/1

Inspection & Testing: M55 SP-110, EN12266

**Advantages:**

Complete Stainless Steel  
Weldness Single Part Body

Max. 690 bar

Max. 400 °C

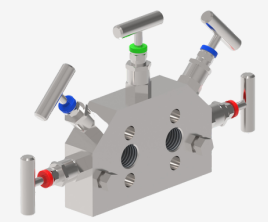
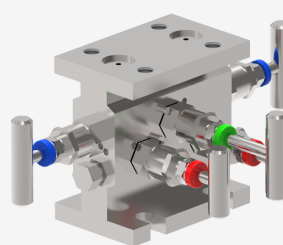
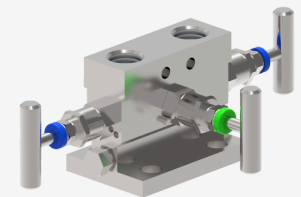
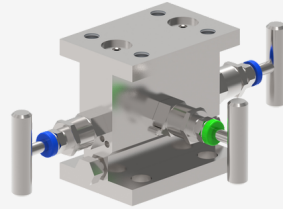
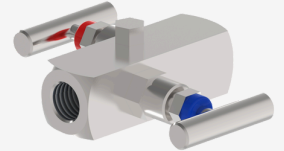
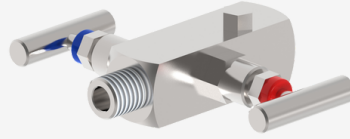

Conductive  
Liquid



Low Conductive  
Liquid

## ETT TEMPERATURE SENSOR AND TRANSMITTER



### ► Technical Specifications

Type	: Stem and wall
Range	: (-)200 °C...(+800 °C
Mechanical Connection	: 1/2" BSP (Std) (Depends on request.)
Electrical Connection	: Socket (ISO 4400) , Terminals, With Cable
Sensor	: 1 x pt100 3 Wires Cable (Class B - EN 60751) (Class A - EN 60751)
Output	: 1 or 2 x Pt 100 2 Wires 4-20 mA (Std.) 3 Wires 4-20 mA, 0-20 mA 0-5 V, 1-5 V, 0-10 V
Supply	: 10 - 30 VDC
Material	: St.St. , PTFE , Aluminium , Plastic
Stem Length	: Min. 10 mm Max. 10m. - On Request
Protection Class (EN60529)	: IP 65 , IP 66
Pipe Diameter	: Ø 6 , Ø 8 , Ø 10 , Ø 11 , Ø 14 mm On Request

### ► ETT

Resistance thermometers are used in the locations where precise temperature measurement is demanded in the industry. It is based on change of electrical resistance of conductor subject to the temperature. It is used the resistance detector that is wound from thin platinum or nickel wire insulated within enamel, glass or ceramic as conductor. Detector provides 100 ohm resistance output in 0°C.

Increasing or decreasing values of resistance subject to temperature are measured and then, temperature is detected.

Copper, silver or nickel-chromium connection wires are added into two ends of resistance detector. It can be used from -200°C to +850°C.

Analogue output information is taken through pt100 sensors in compliance with EN60751 and then, assessed in the automation system.

In order that resistance thermometers can measure accurately, it is recommended that it has dipping length as much as 6 and 15 times of dipping diameter.

Copper or Silver wire is used up to 500 °C and Nickel chromium is used after 550 °C between Pt 100 and connector. Copper conducting wire is used between device and pt100. It should have 2 wires up to 10 m., 3 wires up to 150 m. and 4 wires after 150 m.

#### Advantages :

- Models up to max. of 600 bar
- Practical and economical
- Digital display can be mounted

#### Areas of Application :

- Machines, tank, boilers, gas and liquid fluid,
- surface temp. measurement,
- ambient temperature measurement.



Conductive Liquid



Low Conductive Liquid



Solids Particulate Material

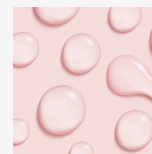

Adhesive and Acid / Basic Liquid



## EPH PH SENSOR PH CONTROL DEVICE

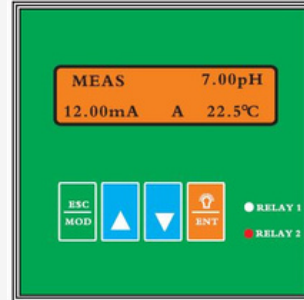

### ► Technical Specifications

### ► EPH

PH	Measure Range	: -2.00 ~ 16.00 pH
	Resolution	: 0.01 pH
	Accuracy	: ± 0.01 pH
ORP	Input Impedance	: $3 \cdot 10^{12}$ W
	Measure Range	: -2000 ~ 2000mV
	Resolution	: 0.01 mV
Temperature	Accuracy	: ±1 mV
	Measure Range	: -25 ~ 130 °C
	Resolution	: 0.01 pH
Signal Output	Sensor	: PT1000
	Compensation	: Automatic / Manual
	PH / ORP	: 4-20 mA (Adjustable)
Relay Output	Current Accuracy	: 1 % FS
	Load	: < 750 W
	On / Off	: 2 SPST Relays
Data interface	Load	: 5A 250VAC / 5A 30 VDC
		: RS485 For (EPH-Ci)
		: Compatible With standard MODBUS-RTU
	Power	: 100 ~ 240 or 24VDC
	Working Tem.	: 0 ~ 60 °C
	Humidity	: < 90 %
	Protection Class	: IP 55
	Installation	: Panel Mounting
	Dimensions	: 96x96x138 mm (H*W*D)
	Weight	: 0.5 kg

### Advantages:

LCD display with backlight, English operation interface. Calibration and setting can set cryptoguard. Technical parameters can be set with buttons on site. High stability, high accuracy, can measure PH, ORP and temperature. Temperature compensation. Multiple output (2 relays, 4-20mA, RS485). Supper anti-interference design can be used for strong interference with field operations and anti-electromagnetic interference. The built-in memory chip ensures that the parameters and calibration data are not lost when shut down or off normally. Can automatically detect the temperature probe and enter the automatic temperature compensation program.

### Application :

Soilless cultivation, aquaculture, water treatment, thermal power, metallurgy, pharmaceutical, enviromental protection, food, tap water, chemical industry etc.

Ensim water quality analysis instrumentation hardware used the precision electronic components, strong anti-interference and reliable stable patent integrated circuit design, which are widely used in aerospace, automotive, military and high-tech fields, simple operation and rich interface software instrumentation system, make the detection signal is more accurate and stable, the current products have been widely used in metallurgy, electronic power, pharmaceutical, chemical, oil, water treatment, food and other industries.





# EBQ GSM CONTROL MONITORING AND TRACKING



## GSM RELAY CONTROL AND WARNING DEVICE



### ► Technical Specifications

### ► EBQ

Model	: EBQ100
Power Need	: 2 VDC 1.5 A
Relay Output	: 8 Panasonic Relay (5 A 277 VAC / 3 A 30 VDC)
Inputs	: 4 (Dry Contact)
LCD	: 2 x 16 LCD
Buzzer	: Yes
Call Notification	: 10 Number
SMS Notification	: 10 Number
Email Notification	: 3 Mail Address (No SSL, May be accepted as spam from servers)
Antenna	: SMA Connector (3 m. GSM Antenna included)
Terminal	: Plug-in Terminal (3.81 mm)
Enclosure	: Rail Type Plastic Enclosure Also suitable for wall mounth 157 mm x 90 mm x 60 mm



## GSM RELAY CONTROL AND WARNING DEVICE

### ► Technical Specifications

### ► EBQ

Model	: EBQ103
Power Need	: 2 VDC 1.5 A
Relay Output	: 2 Panasonic Relay (5 A 277 VAC / 3 A 30 VDC)
Inputs	: 3 (Relay Contact)
Analog Sensor	: 2 Analog Input (1 x 4-20 mA, 1x 10K NTC Temperature Sensor)
Buzzer	: Input)
Call Notification	: No
SMS Notification	: 10 Number
Email Notification	: 10 Number
Antenna	: 10 Mail Address
Terminal	: SMA Connector (3 m. GSM Antenna included)
Enclosure	: Plug-in Terminal (3.81 mm) Rail Type Plastic Enclosure Also suitable for wall mounth 110 mm x 90 mm x 60 mm

## GSM RELAY CONTROL AND WARNING DEVICE



### ► Technical Specifications

### ► EBQ

Model	: EBQ119
Power Need	: 12 - 24 VDC 1 A
Relay Output	: Max 24 Relay with external device (With EBQ352 or EBQ351-19 device)
Dry Contact Input	: Max 24 Input with external device (With EBQ360 or EBQ51-19 device)
Modbus Register	: 8 Modbus Register
Alarm	: 20 Modbus Alarm , 40 Digital Input Alarm
Communication	: RS 232 (For device Settings) RS 485 (Form Modbus Registers)
Buzzer	: Yes
Alarm Notification	: 10 Number for SMS Notification 10 Number for Silent Call
Antenna	: 3 Email Address for Mail Notification SMA Connector (Antenna Included)

### SMS ASSISTANT

SMS Asistan Application makes easy to adjust the settings or to control the all GSM control units. We have both Android and IOS versions. You can add many devices to the software and control them individually. You can add many macros for frequently used settings or control commands.





**EBQ INDUSTRIAL AUTOMATION PRODUCTS**



► Technical Specifications

► EBQ

Model	: EBQ370-02 EBQ370-02N
Power Need	: 24 VDC
Input	: 6 x 4-20 mA Sensor Input
ADC	: 16 Bit 12 Bit
Protocol	: Modbus RTU
Terminal	: Screw Terminal (5.08 mm)
Enclosure	: Rail Type Enclosure 70 mm x 90 mm x 60 mm



► Technical Specifications

► EBQ

Model	: EBQ420
Power	: 24 VDC
Requirements	: GPRS / TCP Ethernet
Internet Access	: 4 Pcs. Relay
Number of Relays	: 1 Pcs.12C
Sensors	: Temperature humidity sensor 4 Pcs. 4,-20 mA sensor 4 Pcs. Digital Input 10 Pcs. RS 485 Mudbus Register
Terminals Type	: Plug-in Terminals (3.81 mm)
Box	: 157 mm x 90 mm x 60 mm



► Technical Specifications

► EBQ

Model	: EBQ485
Voltage Isolation	: 1000 V
USB Connector	: USB A Type Male
RS485 Connector	: Plug-in Terminals (3.81 mm)
Dimensions	: 50 mm x 30 mm x 15 mm

Technical Specifications

► EBQ

Model	: EBQ113
Power Need	: 12 VDC 1.5 A
Relay Output	: 2 Panasonic Relay
Digital Inputs	: Max. 3 level switch
Level Sensor	: 4-20 mA Level Sensor
Temperature Sen.	: 10K NTC Input
Enclosure	: Plastic Rail Type 110 mm x 90 mm x 60 mm

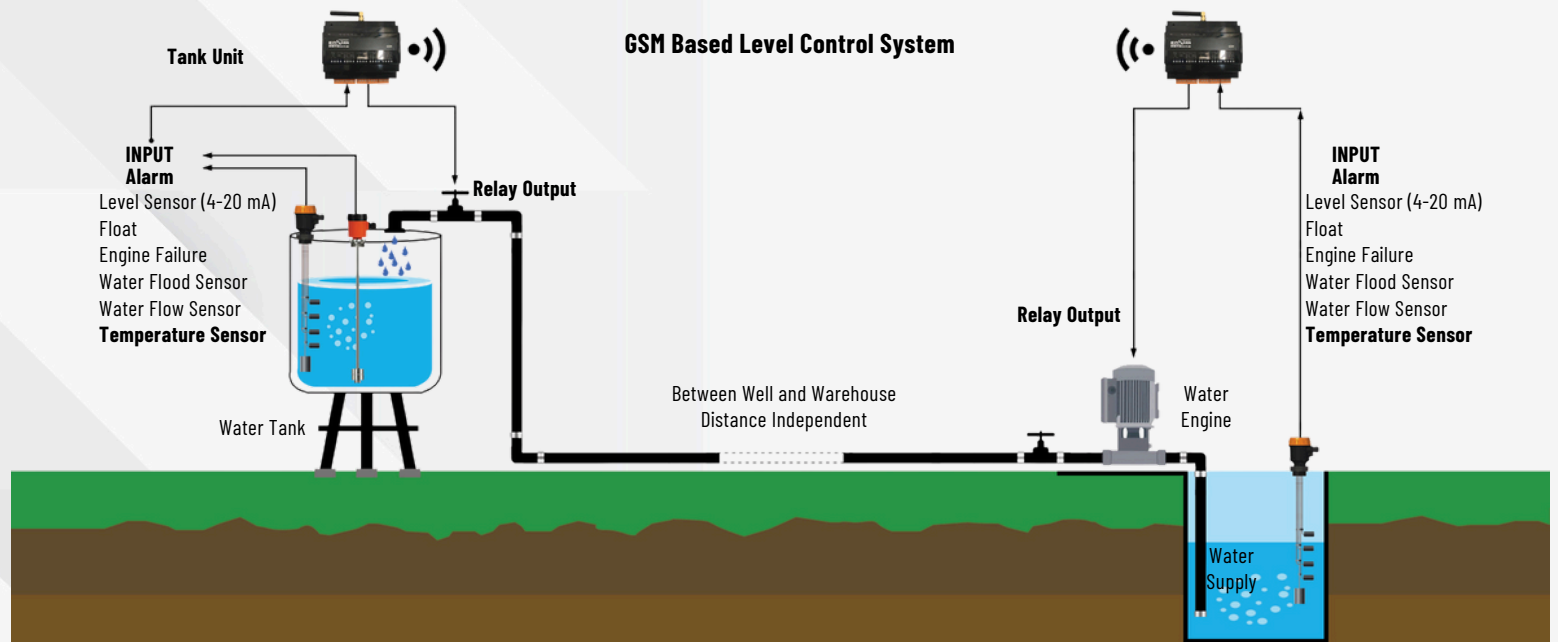





## ENSIM SCADA

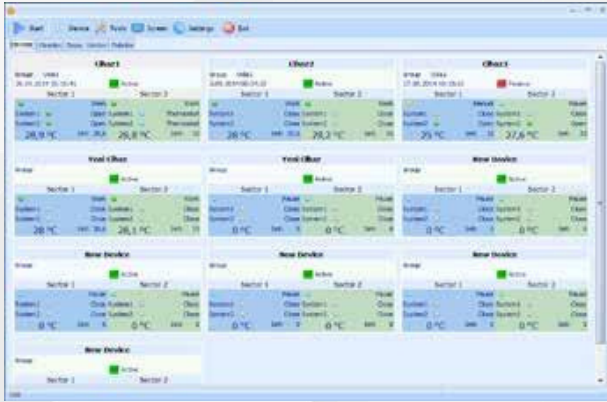

Basic Scada is a program that, easy to use and based on windows operation system. Thanks to this program, you can connect devices from modbus RTU and modbus TCP protocol to read and save the data. Also this program gives you opportunity to control connected devices.

Recorded data can be reported, analysed and shown on graphics. More over this program can produce new virtual parameters with data that read by using mathematical calculations .For example ; You can calculate volume of a tank with using its height, or you can calculate its dew point value with using temperature and humidity information.Due to usage of network based database, data collector programs can be run more than one at different locations from eachother. Also, you can access analyse programs on other computer by using network to get reports.Program can upload the data on our industrial cloud system or create alarm records by your definitions.

## ensim live INDUSTRIAL CLOUD

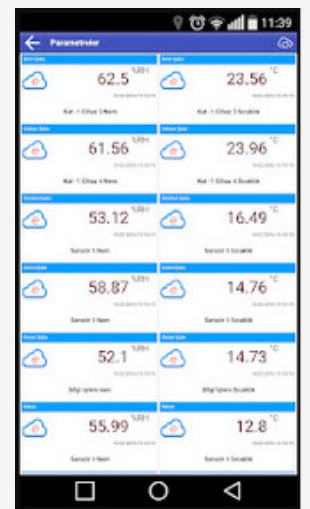
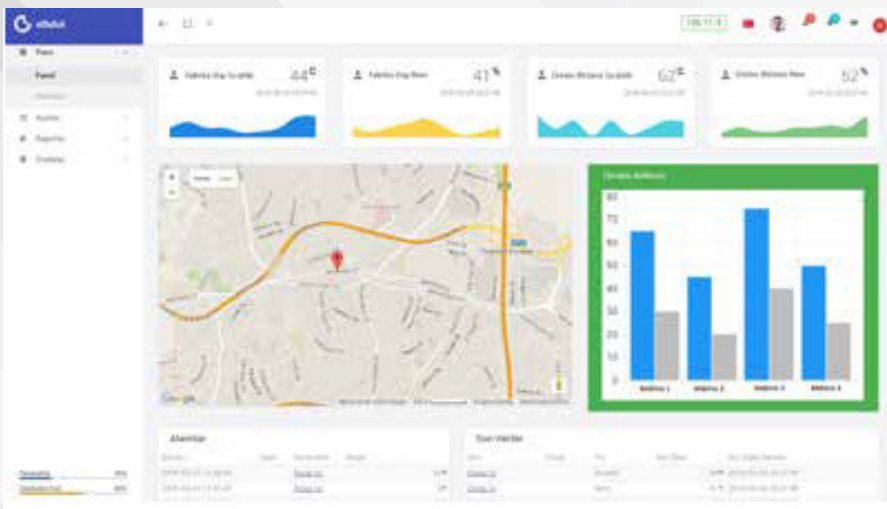

Industrial cloud system is a system that can save data from devices to its own memory for tracking and reporting.Also it can inform its users in critical conditions by creating alarm. You can export you data from PLC and Scada systems to cloud and track them from your phone or tablet device.

You can fastly access important devices data without using web interface by using E-Cloud application which can be downloaded from Apple and Adroid market. You can identify alarm criterias on system parameters to get calls,sms or e- mails in those alarm situations, or get push notifications from mobil devices with "Industrial Cloud Alarm" 1d. Also it is possible to create virtual parameters on system. For example ; You can calculate volume of a tank with using its height, or you can calculate its dew point value with using temperature and humidity information to show as its natural parameter to system. Panel screens can be customized due to usage and you can identify different authority to users. You can view saved data on devices to create reports or graphics.



## HIGH PRECISION INDUSTRIAL PRESSURE MEASUREMENT



### ► Technical Specifications

### ► XMP i

Nominal pressure	: 0 ... 400 mbar to 0 ... 600 bar (XMP i) (turn-down 1:10 adjustable) 0 ... 160 mbar to 0 ... 20 bar (XMP ci) (turn-down 1:5 adjustable)
Accuracy (According to IEC 60770)	: 0.1 % FSO (XMP i) 0.1 / 0.2 % FSO (XMP ci)
Process connection	: Inch and NPT threads, DRD, flange
Housing	: Two chamber aluminium die cast case, stainless steel field housing
Option	: Display and operating module, flameproof enclosure, cooling element up to 300 °C (XMP i), diaphragm 99.9 % Al2 O3 (XMP ci)



### ► Technical Specifications

### ► DMP 331P

Nominal pressure	: 0 ... 400 mbar to 0 ... 40 bar
Accuracy (According to IEC 60770)	: 0.1 % FSO
Characteristics	: Excellent temperature response 0.04 % FSO / 10 K, process connections suitable for hygienic application, vacuum resistant
Option	: IS-version, communication interface for adjustment of offset, span and damping



### ► Technical Specifications

### ► DMP 200

Differential pressure	: 0 ... 1 mbar to 0 ... 20 bar
Accuracy (According to IEC 60770)	: 0,075 % FSO
Characteristics	: Static over pressure 400 bar, rangeability max. 100:1, aluminium die cast case, HART®-communication
Option	: IS-version, LC display, stainless steel housing



### ► Technical Specifications

### ► DMK 331

Nominal pressure	: 0 ... 400 mbar to 0 ... 600 bar
Accuracy (According to IEC 60770)	: 0.5 % FSO
Option	: IS-version, compact field housing, pressure port PVDF, oxygen application, pressure port G 1/2" flush

## HIGH PRECISION INDUSTRIAL PRESSURE MEASUREMENT



### ► Technical Specifications

#### ► DS 400 / 401

Nominal pressure	: 0 ... 100 mbar to 0 ... 600 bar (DS 400) 0 ... 400 mbar to 0 ... 600 bar (DS 401)
Accuracy (According to IEC 60770)	: 0.25 / 0.35 % FSO (DS 400) 0.5 % FSO (DS 401)
Characteristics	: up to 2 contacts, 4-digit LED-display in ball housing, rotatable and configurable display module
Pressure port Option	: Inch and NPT threads : IS-version, pressure port PVDF (DS 401)



### ► DS 201P / 200P

Nominal pressure	: 0 ... 100 mbar to 0 ... 40 bar (DS 200 P) 0 ... 60 bar to 0 ... 400 bar (DS 201 P)
Accuracy	: 0.25 / 0.35 % FSO (DS 200 P) 0.5 % FSO (DS 201 P)
Characteristics	: up to 4 contacts, 4-digit LED-display, rotatable and configurable display module
Pressure port Option	: Inch thread (flush), dairy pipe, clamp, : varivent® (DS 200 P) Cooling element up to 300 °C (DS 201 P)

## HIGH PRECISION INDUSTRIAL PRESSURE MEASUREMENT



### ► Technical Specifications

#### ► LMP 307

<u>Level</u>	: 0 ... 1 mH2 O to 0 ... 250 mH2 O
<u>Temperature</u>	: 0 ... 30 °C to 0 ... 70 °C (LMP 307 T)
<u>Housing material</u>	: Stainless steel 1.4404 (316 L)
<u>Accuracy</u> (According to IEC 60770)	: 0.1 / 0.25 / 0.35 % FSO (LMP 307) 0.25 / 0.35 / 0.5 % FSO (LMP 307 T)
<u>Special feature</u> (LMP 307T)	: 1° C (LMP 307 T) Two galvanic separated signal circuit for pressure and temperature
<u>Option (LMP 307)</u>	: IS-version, cable protection via corrugated pipe, drinking water certificate acc. to DVGW and KTW



### ► Technical Specifications

#### ► LMP 307

<u>Level</u>	: 0 ... 40 cmH2 O to 0 ... 200 mH2 O
<u>Housing material</u>	: stainless steel 1.4404 (316 L), CuNiFe
<u>Accuracy</u> (According to IEC 60770)	: 0.1 / 0.25 % FSO
<u>Special feature</u> (LMP 307T)	: Permissible temperature up to 125 °C, chemical resistance against seawater and HFO
<u>Option (LMP 307)</u>	: IS-version, diaphragm 99.9 % Al2 O3 , screw-in and flange version

## HUMIDITY & TEMPERATURE MEASUREMENT



### ► Technical Specifications

#### Relative humidity measurement

Measuring/sensor element : Capacitive  
 Output range : 0...100 % RH  
 Accuracy : ±2 % RH  
 at 5...95 % RH and 10...40 °C

#### Temperature measurement

Sensor element : Pt100 Class B  
 Output range : -20 ... + 80 °C  
 Accuracy : ±0.2 K (otherwise ±0.3 K)

#### Electrical specifications

Signal output : Supply voltage  
 4...20 mA : 13 ... 24 V DC (intrinsically safe)

### ► Technical Specifications

#### Relative humidity measurement

Measuring/sensor element : Capacitive  
 Output range : 0...100 % RH  
 Accuracy : ±2 % RH  
 at 5...95 % RH and 10...40 °C

#### Temperature measurement

Sensor element : Pt100 Class B  
 Output range : -30 ... +70 °C (-ME)  
 -20 ... + 80 °C  
 -25 ... +125 °C  
 0 ... +200 °C

#### Accuracy

with voltage output : Supply voltage  
 with current output : 13 ... 24 V DC (intrinsically safe)

#### Electrical specifications

#### Signal output

0...10 V : Supply voltage  
 4...20 mA : 3/4-wire 15 ... 30 V DC / 24 V AC  
 2-wire 12 ... 30 V DC



**Ex** II 1/2G Ex ia IIC T4  
**Ex** II 2D Ex tb IIIC T95 °C  
 -40 °C < Ta < +80 °C

Approved for use in potentially explosive atmospheres:  
 EC Type Examination Certificate  
 IBExU 07 ATEX 1114

- ATEX C.Ex
- Operating temp. up to 80 °C
  - Accuracy: ±2 % RH
  - IP 66
  - ATEX approval
  - Categories 1/2 G and 2D
  - Stainless steel sensor tube



- GC / KC / ZC  
 In this series
- Operating temp. up to 200 °C
  - Accuracy: ±2 % RH
  - Options
  - IP 65
  - Pressure-resistant up to 25 bar
  - Stainless steel sensor tube



## HUMIDITY MEASUREMENT FOR PAPER

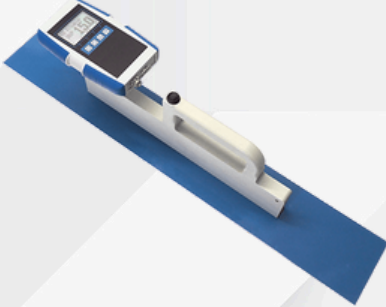

CE

### ► Technical Specifications

Measuring range	: 1 to 50% water content (depending on the
Resolution	: material)
Measuring depth:	: 0.5% water content
Operation	: max. 500mm
temperature	: 0 to +50°C / 32 to 122°F
Protection class:	: IP64

### ► RP

Measurement of compressed bales, roles and pulp possible.  
Measuring range of 1 to 50% water content, measuring depth 500mm.  
Furthermore it is possible to connect external sensors to the humimeter RP6.

#### Automatic temperature compensation

Measurement within seconds without prior treatment of samples  
Hold function, automatic datalog for up to 10,000 logs with measuring point report

#### Your benefits:

Quickly and highly accurate measurement using a non-destructive method Digital displaying in "% " water content (weight percentage) Simple handling of moisture meter  
Pre-programmed calibration for different materials and bale densities Handy, applicable everywhere on site.



### ► Technical Specifications

Measuring range	: 1% to 25% water content
Resolution	: 0.1% water content
Measuring depth:	: 50 mm
Paper temperature for determination	: 0 to +80°C / 32 to 176°F
of water content	
Infrared temperature measurement	: -25 to +125°C / -13 to 257 °F

### ►

For paper manufacturers, paper processors and paper retailers, for a non destructive determination of absolute moisture of paper and cardboard at warm, running paper rolls as well as at stagnant, cool rolls. With non-contact infrared paper temperature measurement. Non-destructive measurement through the packaging!

#### Automatic temperature compensation

Non-contact infrared temperature measurement with 90° optics.

#### Your benefits:

Quick and highly accurate measurement using a non-destructive method Simple handling, small, handy, applicable everywhere on site.

### LIQUID CONCENTRATION AND DENSITY MEASUREMENT

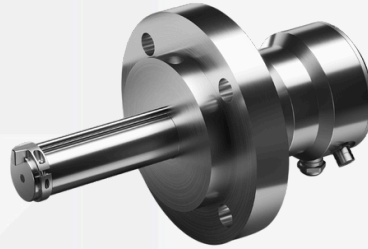

#### ► Technical Specifications

Measurement Range	: 0 ... 100 % concentration.
Accuracy	: ± 0.1 % by weight
Repeatability	: ± 0.02 % by weight
Process pressure	: Up to 25 bar (350 psi) at 20°C (70°F).
Process temperature	: -40°C...150°C
Ambient temperature	: Min. -40°C (-40°F), max. 45°C
Process wetted parts	: AISI 316L stainless steel, prism ; sapphire, prism seal ; modified PTFE.
Protection class	: IP67, Type 4X (for outdoor use).
Current output	: 4-20 mA
Power Supply	: +24 VDC +/-10% , Max 2 VA
Options	: Prism wash, Increased safety (Ex e) certification for hazardous area installations

#### ► PR-53-GP SERIES

**Indication Options :**  
 Multichannel User Interface  
 Compact User Interface  
 Web User Interface

**Typical Applications :**  
 Alkalies And Chlorine  
 Chemicals  
 Plastics, Resins,  
 Fibers And Synthetic Rubber  
 Metal Machining And Mining  
 Salts And Sodium Compounds  
 Effluent And Water Treatment

In-line liquid concentration or density measurement for process control in general industry applications

#### ► Technical Specifications

Measurement Range	: 0 ... 100 % concentration.
Accuracy	: ± 0.1 % by weight
Repeatability	: ± 0.05 % by weight
Process pressure	: Up to 15 bar at 20°C
Process temperature	: -40°C...130°C
Ambient temperature	: Min. -40°C, max. 45°C
Process wetted parts	: AISI 316L stainless steel, prism ; sapphire, prism seal ; modified PTFE.
Protection class	: IP67, Type 4X (for outdoor use).
Options	: Prism wash, Increased safety (Ex e) certification for hazardous area installations

#### ► PR-53-AC SERIES



#### INDICATING TRANSMITTER

Display: 320x240 pixel graphical LCD with LED backlight

Keypad: 18 membrane keys

Current output: , Two independent current outputs, 4-20 mA, max. load 1000 Ohm,  
 galvanic isolation 1500 VDC or AC (peak), hold function during prism wash

Fieldbus and industrial Ethernet connectivity : Through Fieldbus converter to Modbus/TCP, Modbus RTU and Ethernet/ IP networks

Power: AC input 100-240 VAC/50-60 Hz, optional 24 VDC, 30 VA

Alarms/Wash relays: Two built-in signal relays, max. 250 V/3 A

Transmitter protection class : Polycarbonate enclosure IP66, Type 4X (Indoor use);

AISI 304 Stainless steel enclosure IP66 (Indoor use).

#### Typical Applications :

Chemicals, Plastics And Fibers, Pulp And Paper Industry, Salts And Sodium Compounds, Soap And Detergents, Starch Sweeteners, Sugar.

### LIQUID CONCENTRATION AND DENSITY MEASUREMENT



#### ► Technical Specifications

#### ► PR-53-W/M SERIES

Measurement Range	: 0 ... 100 % concentration.
Accuracy	: ± 0.1 % by weight
Repeatability	: ± 0.05 % by weight
Process pressure	: Max 10 bar
Process temperature	: -20°C...130°C
Ambient temperature	: Sensor: -20 °C...45 °C : Indicating transmitter: 0 °C...45 °C
Sensor wetted parts	: lining ; ETFE, prism ; sapphire, prism seal ; modified PTFE O-ring ; : Kalrez , adaptor ; sapphire
Protection class	: IP67, Type 4X (for outdoor use).
Options	: Prism wash, ATEX certified, FM certified

#### Typical Applications :

Chlor-Alkali Industry ,  
Corrosive Chemicals ,  
Ultra Pure Fine Chemicals,  
Electronic Chemicals.

In-line liquid concentration or density measurement for process control in chemically aggressive liquids

#### INDICATING TRANSMITTER

Display: 320x240 pixel graphical LCD with LED backlight

Keypad: 18 membrane keys

Current output: Two independent current outputs, 4-20 mA, max. load 1000 Ohm, galvanic isolation 1500 VDC or AC (peak), hold function during prism wash

Fieldbus and industrial Ethernet connectivity : Through Fieldbus converter to Modbus/TCP, Modbus RTU and Ethernet/ IP networks

Power: AC input 100-240 VAC/50-60 Hz, optional 24 VDC, 30 VA

Alarms/Wash relays: Two built-in signal relays, max. 250 V/3 A

Transmitter protection class : Polycarbonate enclosure IP66, Type 4X (Indoor use);

AISI 304 Stainless steel enclosure IP66 (Indoor use).

#### ► Technical Specifications

#### ► PR-53-AP

Measurement Range	: 0 ... 100 % concentration.
Accuracy	: ± 0.1 % by weight
Repeatability	: ± 0.05 % by weight
Process pressure	: Up to 15 bar at 20°C , 9 bar at 120°C
Process temperature	: -40°C...130°C
Ambient temperature	: Min. -20°C, max. 45°C
Process connection	: Sanitary 3A-clamp 2.5"; Varivent® in-line access unit clamp DN65 or via elbow flow cell (for line sizes of 2.5" and smaller)
Process wetted parts	: Stainless steel 1.4435 (AISI 316L), prism ; sapphire, prism seal ; modified PTFE.
Sensor housing material	: AISI 304 stainless steel
Current output	: Isolated 4-20 mA (1000 Vdc isolation voltage)
Power supply	: +24V, less than 2 W
Ethernet output	: 10/100BaseT Ethernet, web server for configuration and diagnostics, UDP/ IP connection for data acquisition
Protection class	: IP67, Type 4X (for outdoor use).
Options	: Interconnecting cables, flow cells, blind flange for Sanitary clamp 2.5 inch



#### Typical Applications :

Beverages  
Cereals  
Confectionary  
Cultures, Enzymes, Yeast  
Dairy  
Egg  
Flavours And Ingredients  
Fruit And Vegetable Processing  
Product And Cip Interfaces  
Quality Control And Testing  
Sugar Dissolving



## SALES OFFICE

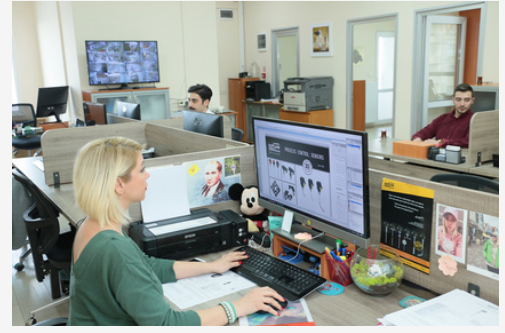

## PRODUCT LINE



## QUALITY CONTROL



# www.ensim.com.tr

## LONCA MAK. SAN. TİC. A.Ş.

 Ferhatpaşa Mah. Gazipaşa Cad. No:104A  
Ataşehir / İSTANBUL - TÜRKİYE 34888  
 Phone:+90 216 505 05 55 / Fax: 216 515 45 84  
 [www.ensim.com.tr](http://www.ensim.com.tr) / [lonca@ensim.com.tr](mailto:lonca@ensim.com.tr)

 LOCATION



 WEB

